

JBG^{HT}

INSTALLER MANUAL

HEAT PUMP



**ZHHH-P1-010K-R290-R5-M | ZHHH-P1-006K-R290-R5-M
ZHHH-Z1-010K-R290-R5-M**

CAUTION!

IT IS ESSENTIAL TO READ THE
INSTRUCTION MANUAL BEFORE USE!

JBG-2 SP. Z O.O. RESERVES THE RIGHT TO MAKE CHANGES TO THE PRODUCTS AND INFORMATION CONTAINED IN THE DOCUMENTATION WITHOUT NOTICE. ALL RIGHTS RESERVED.

Translation of the original manual

TABLE OF CONTENTS

1. CHARACTERISTICS	5
1.1. Idea of action for the heat pump	8
2. SAFETY	9
2.1. Systemy oznaczeń	9
2.2. Before first use	10
2.3. Important warnings	10
2.4. Risks as a result of product changes	11
2.5. Risks of personal injury and property damage as a result of improper maintenance and repair or failure to do so	11
2.6. Risk related to improper use	12
2.7. Risk of burn injury	12
2.8. Risk of malfunction due to incorrect electrical supply	12
2.9. Risk of environmental contamination from leaking refrigerant	12
3. DOCUMENTATION	13
3.1. Description of Monoblock pump operation	13
3.1.1. Product conformity (CE marking)	13
3.2. Schematic of heat pump operation	13
3.2.1. Pump operation in heating mode	13
3.2.2. Pump operation in cooling mode	14
3.2.3. Heat pump operation envelope	15
3.3. Pump design	16
3.3.1. Pompa ZHHH-P1-010K-R290-R5-M i Pompa ZHHH-P1-006K-R290-R5-M	16
3.3.2. Pompa ZHHH-Z1-010K-R290-R5-M	17
3.3.3. Indoor unit Hydrobox (Option)	19
3.3.4. Indoor unit Hydrotower (Option)	21
4. SAFE TRANSPORTATION, INSTALLATION AND STORAGE	23
4.1. General Guidelines	23
4.2. Location of the pump in relations to noise emission	24
4.3. Transportation	24
4.4. Unpacking the product	24
4.5. Storage	24
4.6. Mechanical installation and mounting	24
4.6.1. Setting up the outdoor unit – general guidelines	25
4.7. Defrost mode	28
4.8. Electrical installation	28
4.8.1. Requirements	28
4.8.2. Installation diagrams	31

4.9. Hydraulic system	33
4.9.1. Requirements	33
4.9.2. Hydraulic system diagrams	35
4.9.3. Diagram of the refrigeration system	38
4.9.4. Water supply system	39
4.9.5. Filling up and venting the system	40
4.9.6. Installing the DHW sensor	40
4.9.7. Initial commissioning	40
5. STARTING UP THE HEAT PUMP	41
5.1. User interface	41
5.2. Setting knob operation	41
5.3. Configuration of the operating device	42
5.4. Initial commissioning	44
5.5. Controller main menu icons	58
5.6. Controller home screen	59
5.7. Heating/cooling side	60
5.8. Time programmes for heating/cooling	60
5.9. Hot water side	61
5.10. Information page	61
5.11. Maintenance/Settings page	63
5.12. Login	65
6. ALARMY	66
7. MAINTENANCE, INSPECTION AND REPAIR	66
7.1. Maintenance notes	66
7.2. Safety parameters	67
7.3. Disassembly and disposal	67
7.4. Decommissioning the appliance	67
7.5. Residual risk	68
7.6. Error codes	68



1. CHARACTERISTICS

MONOBLOCK HEAT PUMP			
ZHHH-P1-010K-R290-V5-M			
Performance data – heating (EN 14511)			
①	A7/W35	Power range (min-max) ¹	kW 1,93 - 11,14
		Partial load ¹	kW 6,34
		Power consumption ¹	kW 1,35
		COP ¹	4,68
②	A7/W55	Maximum power ²	kW 10,92
		Partial load ²	kW 8,34
		Power consumption ²	kW 2,91
		COP ²	2,90
③	A2/W35	Maximum power ³	kW 10,26
		Partial load ³	kW 6,30
		Power consumption ³	kW 1,62
		COP ³	3,86
④	A-7/W35	Maximum power ⁴	kW 8,25
		Power consumption ⁴	kW 2,95
		COP ⁴	2,80
Performance data – cooling			
⑤	A35/W18	Maximum power ⁵	kW 8,8
		Partial load ⁵	kW 6,64
		Power consumption ⁵	kW 1,36
		EER ⁵	4,88
⑥	A35/W7	Maximum power ⁶	kW 8,0
		Partial load ⁶	kW 5,04
		Power consumption ⁶	kW 1,50
		EER ⁶	3,36
Product data			
Pump type			air / water
Refrigerant type			R290
Refrigerant amount		kg	1,30
Maximum working pressure		bar	31
Compressor type			twin rotary
Adjustment type			electronic
Heating			
Minimum working pressure		bar	1,0
Maximum working pressure		bar	3,0
Rated flow		m ³ /h	1,17
External operating temperature range		°C	from -22 to +35
Feed water temperature		°C	from +20 to +65
Physical dimensions			
Depth x width x height		mm	505 x 1155 x 935
Weight		kg	132
Water connections			G 5/4 *
Sound power level		dB	50
Air flow		m ³ /h	3500
Electrical data			
Electrical connection		V/Ph/Hz	230 / 1* / 50
Protection rating			IP24
Electric heater power (option with hydrobox / hydrotower)		kW	3 / 6 / 9
Fan power consumption		W	50
Number of fans			1
Fan rotor speed		RPM	700
SCOP			W35 4,88 / W55 3,69
Energy efficiency class			W35 A+++ / W55 A++
Device with a regulator – feed temperature 35°C / 55°C			

- ① Heating temperature: water I/O temperature: 30°C / 35°C,
 water I/O temperature: 40°C / 45°C,
 ② Heating temperature: water I/O temperature: 50°C / 55°C,
 ③ Heating temperature: water I/O temperature: 30°C / 35°C,
 ④ Heating temperature: water I/O temperature: 23°C / 18°C,
 ⑤ Cooling temperature: water I/O temperature: 12°C / 7°C,
 ⑥ Cooling temperature:

- Ambient temperature: DB 7°C / WB 6°C,
 Ambient temperature: DB 7°C / WB 6°C,
 Ambient temperature: DB 7°C / WB 6°C,
 Ambient temperature: DB 2°C / WB 1°C,
 Ambient temperature: DB 35°C,
 Ambient temperature: DB 35°C,

MONOBLOCK HEAT PUMP			
ZHHH-P1-006K-R290-V5-M			
Performance data – heating (EN 14511)			
①	A7/W35	Power range (min-max) ¹	kW 1,93 - 6,03
		Partial load ¹	kW 6,03
		Power consumption ¹	kW 1,25
		COP ¹	4,81
②	A7/W35	Maximum power ²	kW 5,51
		Power consumption ²	kW 1,77
		COP ²	3,12
③	A2/W35	Maximum power ³	kW 5,17
		Power consumption ³	kW 1,22
		COP ³	4,25
④	A-7/W35	Maximum power ⁴	kW 3,97
		Power consumption ⁴	kW 1,14
		COP ⁴	3,48
Performance data – cooling			
⑤	A35/W18	Maximum power ⁵	kW 6,64
		Power consumption ⁵	kW 1,36
		EER ⁵	4,88
⑥	A35/W7	Maximum power ⁶	kW 4,35
		Power consumption ⁶	kW 1,44
		EER ⁶	3,03
Product data			
Pump type			air / water
Refrigerant type			R290
Refrigerant amount		kg	1,30
Maximum working pressure		bar	31
Compressor type			twin rotary
Adjustment type			electronic
Heating			
Minimum working pressure		bar	1,0
Maximum working pressure		bar	3,0
Rated flow		m ³ /h	117
External operating temperature range		°C	od -22 do +35
Feed water temperature		°C	od +20 do +65
Physical dimensions			
Depth x width x height		mm	505 x 1155 x 935
Weight		kg	132
Water connections			G 5/4 "
Sound power level		dB	50
Air flow		m ³ /h	3500
Electrical data			
Electrical connection		V/Ph/Hz	230 / 1* / 50
Protection rating			IP24
Electric heater power (option with hydrobox / hydrotower)		kW	3 / 6 / 9
Fan power consumption		W	50
Number of fans			1
Fan rotor speed		RPM	700
SCOP		W35 4,95 / W55 3,63	
Energy efficiency class		W35 A+++ / W55 A++	
Device with a regulator – feed temperature 35°C / 55°C			

- ① Heating temperature:
- ② Heating temperature:
- ③ Heating temperature:
- ④ Heating temperature:
- ⑤ Cooling temperature:
- ⑥ Cooling temperature:

water I/O temperature: 30°C / 35°C,
 water I/O temperature: 40°C / 45°C,
 water I/O temperature: 50°C / 55°C,
 water I/O temperature: 30°C / 35°C,
 water I/O temperature: 23°C / 18°C,
 water I/O temperature: 12°C / 7°C,

Ambient temperature: DB 7°C / WB 6°C,
 Ambient temperature: DB 7°C / WB 6°C,
 Ambient temperature: DB 7°C / WB 6°C,
 Ambient temperature: DB 2°C / WB 1°C,
 Ambient temperature: DB 35°C,
 Ambient temperature: DB 35°C,



MONOBLOCK HEAT PUMP			
ZHHH-Z1-010K-R290-V5-M			
Performance data – heating (EN 14511)			
①	A7/W35	Power range (min-max) ¹	kW 2,44 - 11,03
		Partial load ¹	kW 6,20
		Power consumption ¹	kW 1,43
		COP ¹	4,34
②	A7/W55	Maximum power ²	kW 10,81
		Partial load ²	kW 8,29
		Power consumption ²	kW 3,08
		COP ²	2,69
③	A2/W35	Maximum power ³	kW 10,15
		Partial load ³	kW 6,10
		Power consumption ³	kW 1,68
		COP ³	3,63
④	A-7/W35	Maximum power ⁴	kW 8,17
		Power consumption ⁴	kW 2,98
		COP ⁴	2,74
Performance data – cooling			
⑤	A35/W18	Maximum power ⁵	kW 8,63
		Partial load ⁵	kW 6,51
		Power consumption ⁵	kW 1,44
		EER ⁵	4,52
⑥	A35/W7	Maximum power ⁶	kW 7,84
		Partial load ⁶	kW 4,94
		Power consumption ⁶	kW 1,59
		EER ⁶	3,11
Product data			
	Pump type		air / water
	Refrigerant type		R290
	Refrigerant amount	kg	1,30
	Maximum working pressure	bar	31
	Compressor type		twin rotary
	Adjustment type		electronic
Heating			
	Minimum working pressure	bar	1,0
	Maximum working pressure	bar	3,0
	Rated flow	m ³ /h	117
	External operating temperature range	°C	from -22 to +35
	Feed water temperature	°C	from +20 to +65
Physical dimensions			
	Depth x width x height	mm	505 x 1155 x 935
	Weight	kg	132
	Water connections		G 5/4 "
	Sound power level	dB	50
	Air flow	m ³ /h	2500
Electrical data			
	Electrical connection	V/Ph/Hz	400 / 3* / 50
	Protection rating		IP24
	Electric heater power (option with hydrobox / hydratower)	kW	3 / 6 / 9
	Fan power consumption	W	50
	Number of fans		1
	Fan rotor speed	RPM	700
SCOP		W35 4,69 / W55 3,38	
Energy efficiency class		W35 A+++ / W55 A++	
Device with a regulator – feed temperature 35°C / 55°C			

① Heating temperature:

water I/O temperature: 30°C / 35°C,

Ambient temperature: DB 7°C / WB 6°C;

② Heating temperature:

water I/O temperature: 40°C / 45°C,

Ambient temperature: DB 7°C / WB 6°C;

③ Heating temperature:

water I/O temperature: 50°C / 55°C,

Ambient temperature: DB 7°C / WB 6°C;

④ Heating temperature:

water I/O temperature: 30°C / 35°C,

Ambient temperature: DB 2°C / WB 1°C;

⑤ Cooling temperature:

water I/O temperature: 23°C / 18°C,

Ambient temperature: DB 35°C;

⑥ Cooling temperature:

water I/O temperature: 12°C / 7°C,

Ambient temperature: DB 35°C;

1.1. Idea of action for the heat pump

The principle of the heat pump is to collect heat from the so-called low-temperature lower source (-22°C to +35°C) and transfer the heat to the high-temperature upper source (the central heating and DHW system). This process is carried out with electricity supplied to drive the compressor.

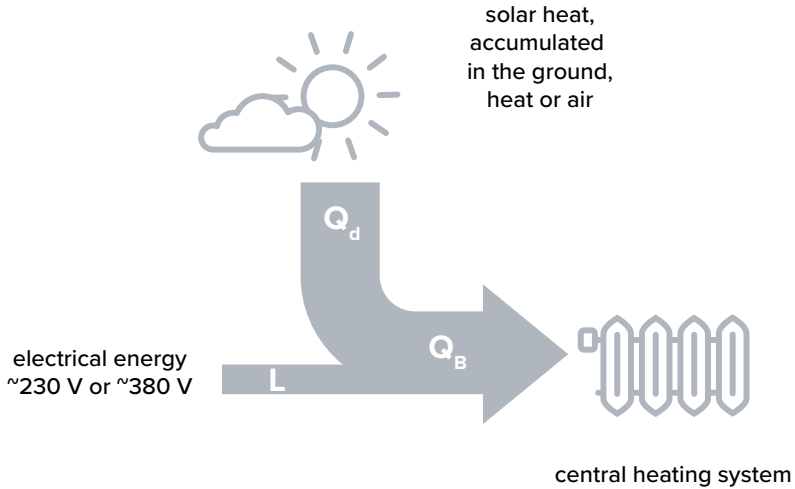

Fig. 1. Principle of operation of a heat pump

In heat pump systems, it is possible to use both the hot side (upper source), e.g. for heating purposes, and the cold side (lower source - air), e.g. for air conditioning or refrigeration. In the heat pump settings, we can select the following modes of operation:

- Plant – central heating,
- DHW – domestic hot water,
- Plant + DHW – central heating + domestic hot water,
- Cooling,
- Cooling + DHW.



2. SAFETY



Before using the device, it is essential to read the instruction manual. Failure to do so may lead to improper operation of the device, malfunction, and may endanger the lives of those operating the device.

- 1) The manual contains rules for handling the product, both before its first start-up and during use.
- 2) The content highlights descriptions of situations to which special attention should be paid.
- 3) If the following content is not adhered to, the product may be damaged even irreparably.
- 4) The manual is an integral part of the unit, it should be delivered to the user together with the equipment. The manual should be retained for reuse.
- 5) If the device is resold or possession is otherwise transferred to another party, make sure that the manual is transferred with the device.
- 6) If any damage is detected during transport - the device must not be connected to the mains electricity(contact service).
- 7) Use the device in accordance with the purpose for which it was designed.
- 8) Before connecting the device, check the correctness of the electrical connections and the effectiveness of the grounding system.
- 9) If the warranty seals are removed, inform the service center.
- 10) Children and persons with a diagnosed disability limiting physical, sensory or mental abilities may use the heat pump only under the supervision of a person to whom the limitations listed in this section do not apply.

2.1. Marking system



Attention - important content. Procedure to which special attention should be paid.



Warning – sudden (loud) noise



Caution - a task that requires special attention. Very important information regarding use.



Warning – automatic activation.



Electricity - information about the electrical system, tasks related to connecting the device to the electrical network.



Warning – low temperature



Gloves - activities that require additional personal protection.



Warning, fire hazard / flammable material.



A ban placed on electrical and electronic devices reminding the public not to throw items in trash containers.



Fire, open flame and smoking prohibited.



Caution - hot surfaces.



Follow operating instructions.



Caution - moving parts.



Read the instructions for use/operation.



Warning - harmful substance, risk of suffocation



Service indications: Check in the operating instructions.



Warning – risk of explosion.

Tab. 1. Marking system used

2.2. Before first use



The device should not be accessed by unqualified, outsiders.

Inside the device there are components powered by electric voltage, which are life-threatening in case of direct contact. Any work in the vicinity of the electrical board must be carried out only by qualified and authorized personnel with the appropriate professional authorizations and in compliance with health and safety rules.

The electrical connection must be made by an electrician with the appropriate qualifications.

Installation, assembly and commissioning work should be carried out by a person with appropriate qualifications.

Before opening the housing, disconnect the electrical power supply.

For installation and maintenance, use appropriate tools and direct protection equipment.

External surfaces of apparatus and equipment inside the unit may be hot and cause burns.

2.3. Important warnings



The device is not intended for use by children.



Read this manual before use.



Assembly, disassembly, installation work and maintenance of the device must be performed by qualified personnel.

It is forbidden to make any changes to the structure of the unit. Failure to do so may result in injury to persons or damage to the unit.

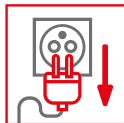

Before performing any operations on the unit, make sure that the electrical power to the heat pump unit is turned off. If the power cord becomes loose or damaged, make sure to always call a qualified person to repair it.



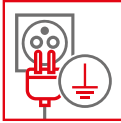

The power supply to the device must be grounded.



The device should be kept away from environments that are flammable or corrosive.



A dedicated electrical connection should be used to power the device, otherwise, failure may occur.



Do not touch the grille of the air exhaust and outlet.



Do not direct a stream of water directly on the device. Power leakage or product failure may occur.



When the device is in operation, never cover it with clothes, cloth or other material that blocks the ventilation of the product, as this may lead to low efficiency or even malfunction of the device.

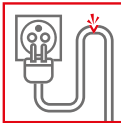

If the power cord is damaged, take the device out of service and call a qualified person to repair it.



It is mandatory to use the appropriate heat pump circuit breaker and make sure that the power supply complies with the specifications. Otherwise, the unit may be damaged.

Tab. 2. Important warnings

2.4. Risks as a result of product changes



- Never remove, bridge or block safety devices.
- Do not tamper with safety devices.
- Do not make any changes to the product, to the supply lines, to the heating circuit safety valve.

2.5. Risks of personal injury and property damage as a result of improper maintenance and repair or failure to do so



- Perform maintenance annually before the heating season.
- Never perform repairs or maintenance work yourself.
- Have an authorized installer perform repairs and maintenance work.
- Adhere to designated maintenance intervals.

2.6. Risk related to improper use



Improper use can lead to damage to the heat pump, danger to those operating the unit and others in the vicinity.

2.7. Risk of burn injury



The pipes from the water exchanger located in the heat pump should be carefully insulated, since the maximum possible temperature of the pipes is 75 degrees Celsius.

2.8. Risk of malfunction due to incorrect electrical supply



Avoid interference with the operation of the product, the electrical supply should be within the specified limits:

- 1-phase: ~230 V (+10%), 50 Hz (ZHHH-P1-010K-R290-R5-M i ZHHH-P1-006K-R290-R5-M)
- 3-phase: ~400 V (+10%), 50 Hz (ZHHH-Z1-010K-R290-R5-M)

2.9. Risk of environmental contamination from leaking refrigerant



The product contains refrigerant R290 called natural refrigerant gas. The GWP rating of this refrigerant is 3.

Only an installer with the proper licenses issued by the manufacturer and protective equipment may perform installation and maintenance work.



R290

Installation of the unit must be a minimum of 1 m away from windows, doors, lighting ducts, roof windows, hatches, drain pipes and ventilation ducts due to possible leakage of flammable gas.



In case of repairs, do not use sparking devices or other devices that can cause an ignition of the refrigerant.



Condensate drainage must not be introduced into the sewer system, as it may create an explosive atmosphere.



R290

Do not use open flames or other devices that can heat up the temperature to 370°C in the heat pump environment.



R290

In the event of a leak or suspected leak of refrigerant, immediately turn off the unit. Then remove any equipment from the environment that may be a potential source of fire and contact the service department.



3. DOCUMENTATION

3.1. Description of Monoblock pump operation

A monobloc heat pump is a compact unit containing all the components of the refrigeration system and the heat exchanger in which the heating medium for central heating and domestic water is heated.

The outdoor unit contains refrigeration components including the fan, evaporator and compressor, condenser, valves and auxiliary fittings. The compressor **5** pumps hot gas which goes to the four-way valve which performs the function of switching heating/cooling modes (defrost), then the gas goes to the condenser **6** in which it gives up heat to the medium (water, glycol) which then goes to the facility for heating or hot water. The condensed, subcooled medium in the form of liquid goes to the electronic expansion valve (EEV) **4**, where expansion takes place, then goes to the lower heat source (evaporator) **1** the medium takes heat from the environment this is done by air flow through a fan forced exchanger **2**.

The refrigerant in the evaporator evaporates and returns in the gas fraction to the compressor.

The indoor installation is equipped with a three-way valve (3-WAY), which distributes the heated medium for central heating or hot water purposes (in priority). In the case of very low ambient temperatures and the required higher temperature for heating purposes, an electric heater (with the option of hydrobox / hydrotower) is additionally used to raise the temperature parameter of the medium, which also has a protective function in the event of failure of the refrigeration system to ensure a positive temperature and minimize the risk of freezing of the medium in the condenser.

3.1.1. Product conformity (CE marking)

CE marking or CE marking placed on a product is a manufacturer's declaration that the marked product conforms to the directives so-called New Approach of the European Union.

The declaration of conformity is available for inspection from the manufacturer.

3.2. Schematic of heat pump operation

3.2.1. Pump operation in heating mode

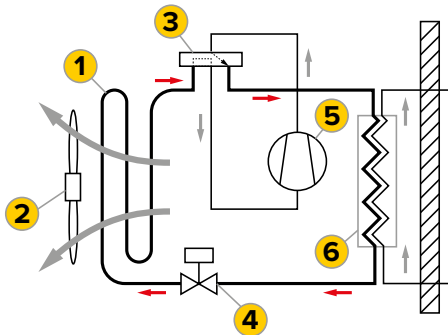

Fig. 2. Heat pump heating mode

1 Heat exchanger – evaporator

2 Fan

3 Four-way valve

4 Electronic expansion valve

5 Compressor

6 Heat exchanger – condenser

3.2.2. Pump operation in cooling mode

The cooling mode of the heat pump is implemented by changing the direction of the refrigerant and heat flow. This occurs by switching the four-way valve, resulting in a reversal of the roles of the condenser and evaporator. In this arrangement, heat is extracted from the rooms and transferred to the device acting as a condenser.

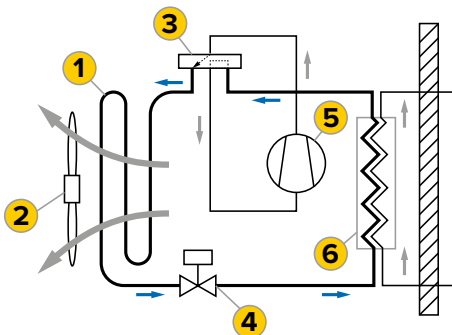

Fig. 3. Heat pump cooling mode

- | | |
|-------------------------------------|--------------------------------------|
| 1 Heat exchanger – condenser | 4 Electronic expansion valve |
| 2 Fan | 5 Compressor |
| 3 Four-way valve | 6 Heat exchanger – evaporator |

The heat pump uses a natural refrigerant which is R290 or Propane.

Table 3 shows the dedicated gas quantity for JBG-2 pump systems.

DATA	ZHHH-P1-006K-R290-R5-M ZHHH-P1-010K-R290-R5-M	ZHHH-Z1-010K-R290-R5-M
Information on the substance used	Natural gas	Natural gas
Type of factor	R290	R290
GWP rating for R290 refrigerant	3	3
Amount of refrigerant in PC circuit	1,3 kg	1,3 kg

Tab. 3. Dedicated amount of refrigerant



3.2.3. Heat pump operation envelope

The heat pump is able to operate under certain conditions. Approaching the limits may cause it to go outside the operation envelope, so in such a case safety mechanisms are activated. In the event of going outside the operation envelope, the unit is shut down.

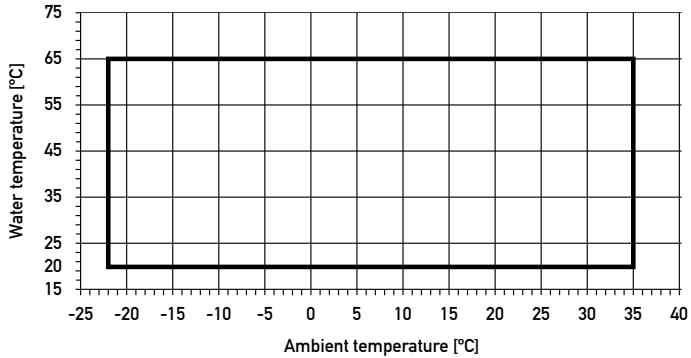

*Applies to models:

ZHHH-P1-006K-R290-R5-M

ZHHH-P1-010K-R290-R5-M

ZHHH-Z1-010K-R290-R5-M

Fig. 4. Heat pump operation envelope in heating mode

3.3. Pump design

3.3.1. ZHHH-P1-010K-R290-R5-M Pump and ZHHH-P1-006K-R290-R5-M Pump

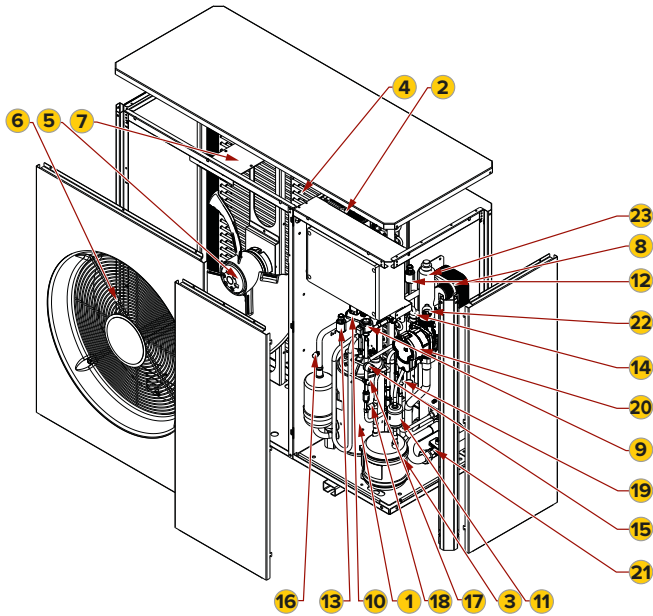

Fig. 5. Design of the heat pump outdoor unit ZHHH-P1-010K-R290-R5-M

1	Compressor	13	HP Pressure transmitter
2	Compressor inverter	14	LP Pressure switch
3	Water tank	15	HP Pressure switch
4	Evaporator	16	LP Service port
5	Fan	17	HP Service port
6	Fan mesh	18	Service valve
7	Fan support	19	Check valve
8	Condenser	20	Circulation pump
9	Electronic expansion valve EEV	21	Flow sensor
10	Four-way valve	22	Water pressure transducer
11	Dehydrator filter	23	Vent
12	LP Pressure transmitter		

Tab. 4. Description of the marked parts of the heat pump outdoor unit



3.3.2. Pompa ZHHH-Z1-010K-R290-R5-M

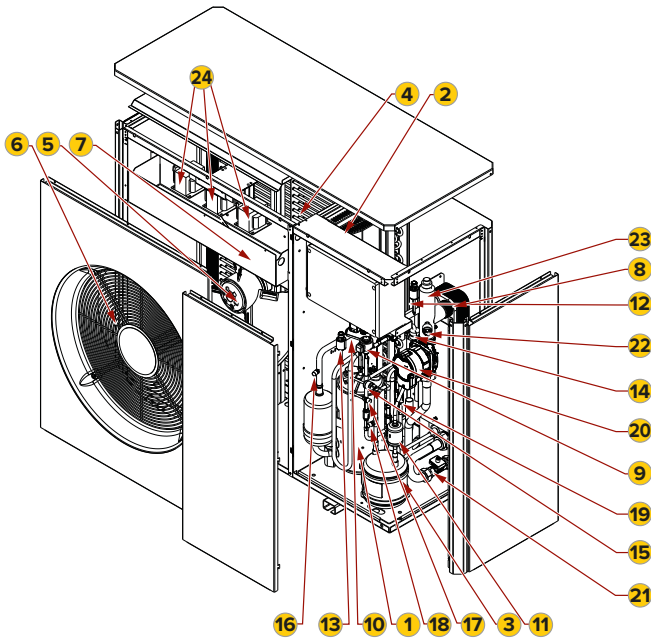

Fig. 6. Design of the heat pump outdoor unit ZHHH-Z1-010K-R290-R5-M

1 Compressor	13 HP Pressure transmitter
2 Compressor inverter	14 LP Pressure switch
3 Water tank	15 HP Pressure switch
4 Evaporator	16 LP Service port
5 Fan	17 HP Service port
6 Fan mesh	18 Service valve
7 Fan support	19 Check valve
8 Condenser	20 Circulation pump
9 Electronic expansion valve EEV	21 Flow sensor
10 Four-way valve	22 Water pressure transducer
11 Dehydrator filter	23 Vent
12 LP Pressure transmitter	24 Choke DC

Tab. 5. Description of the marked parts of the heat pump outdoor unit

Front view



Photo 1. Picture of the heat pump front view

Rear view



Photo 2. Picture of the heat pump rear view

3.3.2.1. External dimensions

Front view

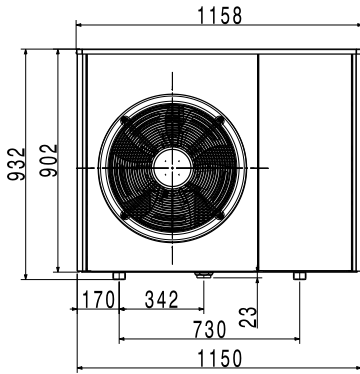

Fig. 7. External dimensions of the heat pump front view

Side view

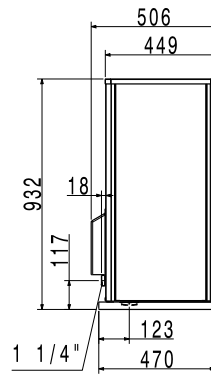

Fig. 8. External dimensions of the heat pump side view

Rear view

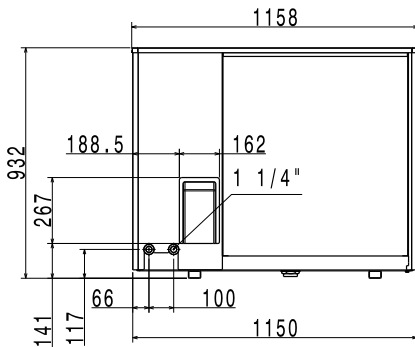

Fig. 9. External dimensions of the heat pump rear view

Bottom view

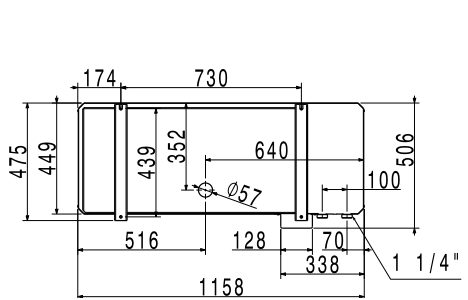

Fig. 10. External dimensions of the heat pump bottom view



3.3.3. Indoor unit Hydrobox (Option)

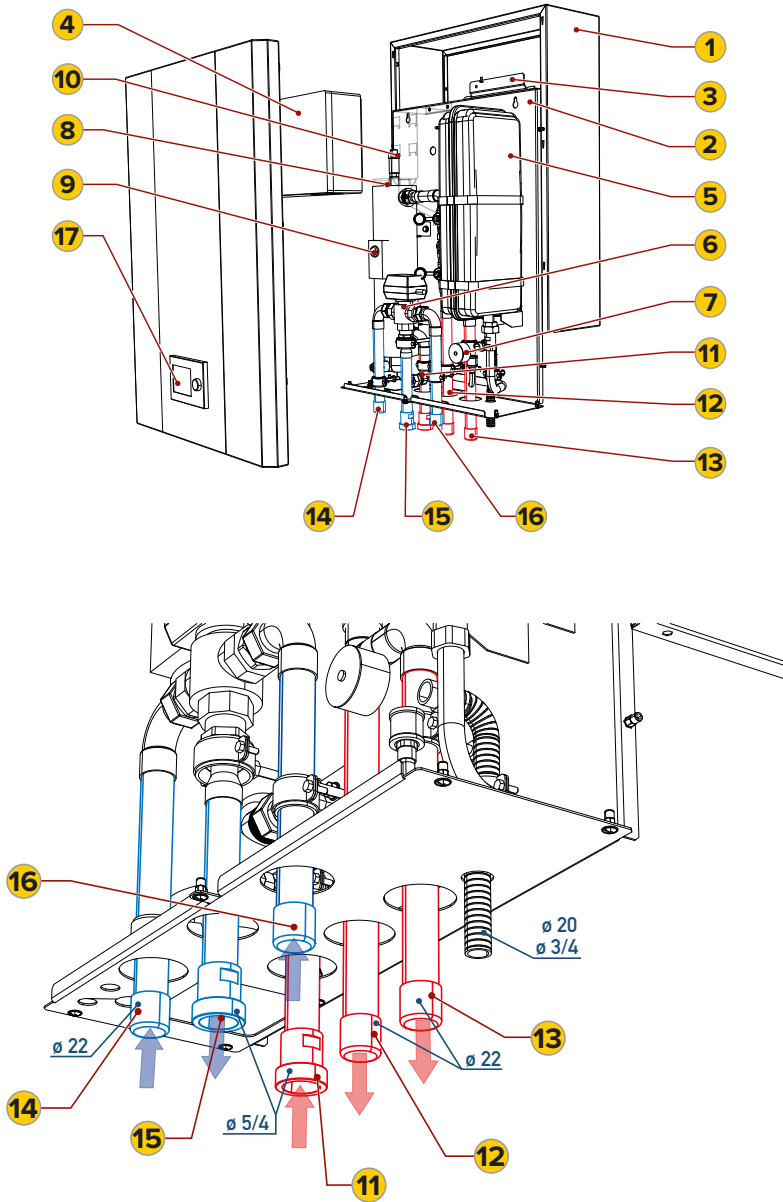

Fig. 11. Diagram of the hydraulic module

1	Casing	11	Automatic bleed valve
2	Mounting panel	12	HP outlet
3	Mounting bracket	13	CH inlet
4	Control box	14	DHW inlet
5	Display	15	CH outlet
6	Diaphragm vessel	16	HP inlet
7	3-way valve	17	DHW outlet
8	Pressure gauge – safety bar	HP	Heat pump
9	Electric heater	DHW	Domestic hot water
10	Safety thermal switch	CH	Central heating

Tab. 6. Description of the marked parts of the Hydrobox

3.3.3.1. External dimensions

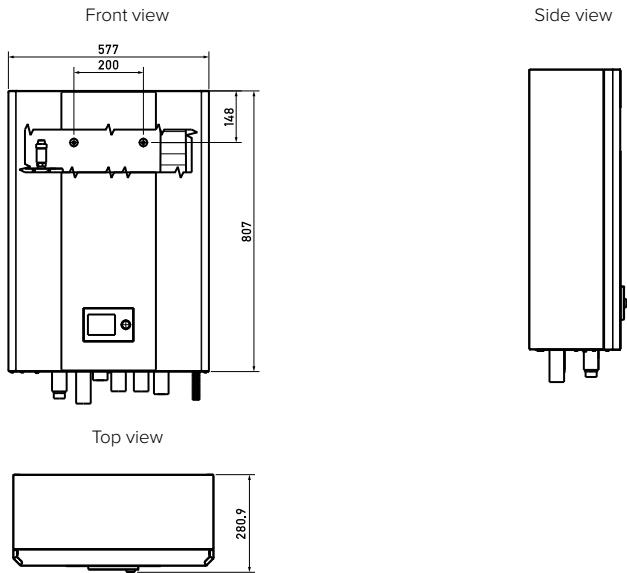

Fig. 12. External dimensions of the hydraulic module



3.3.4. Indoor unit Hydrotower (Option)

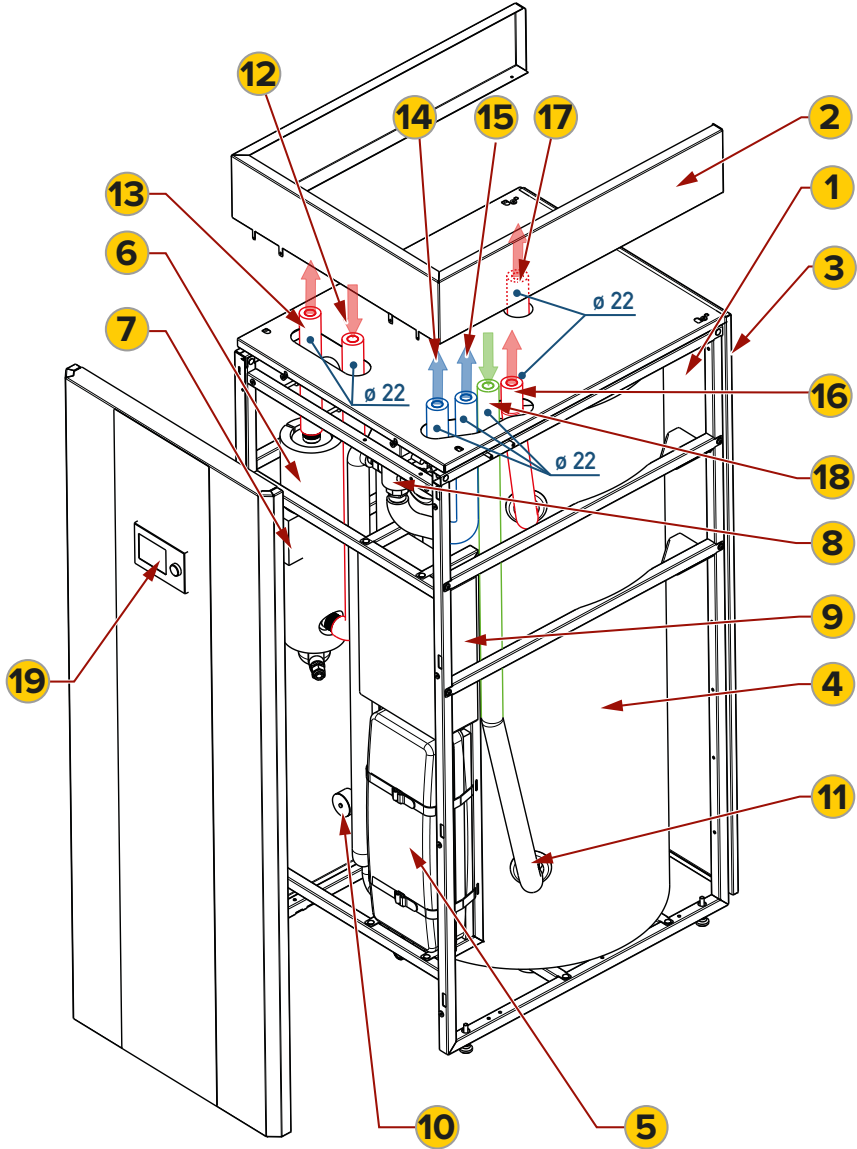

Fig. 13. Diagram of the hydraulic tower

1	Casing	12	HP outlet
2	Top cover	13	CH inlet
3	Mounting frame	14	CH outlet
4	DHW tank 200 l	15	HP inlet
5	Expansion vessel	16	DHW circulation
6	Electric heater	17	DHW inlet
7	Safety thermal switch	18	Cold water inlet
8	Automatic bleed valve	19	Control panel
9	3-way valve	HP	Heat pump
10	Pressure gauge – safety bar	DHW	Domestic hot water
11	Drain valve	CH	Central heating

Tab. 7. Description of the marked parts of the Hydrotower

3.3.4.1. External dimensions

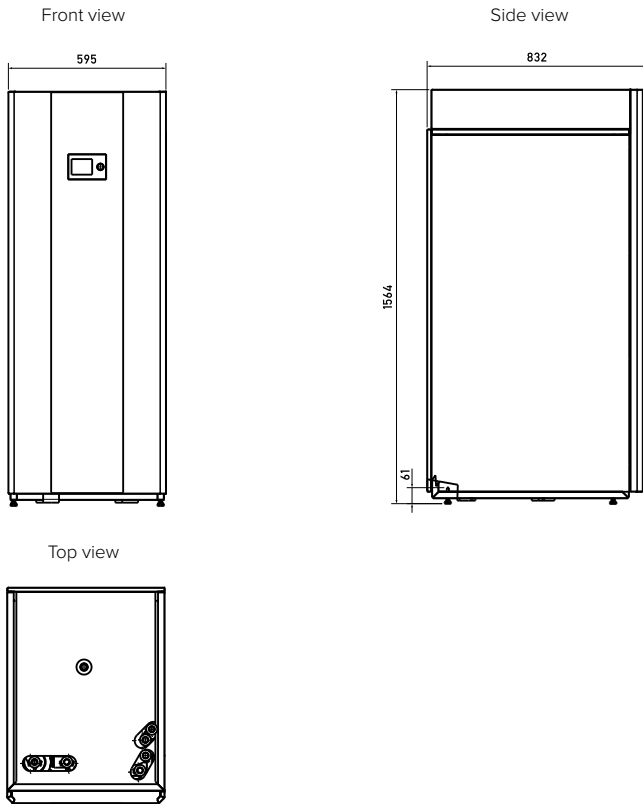

Fig. 14. External dimensions of hydraulic tower



4. SAFE TRANSPORTATION, INSTALLATION AND STORAGE

4.1. General Guidelines

- 1) Installation activities must be carried out only by qualified installers with appropriate authorizations (heating installers, sanitary installers, refrigeration technicians (in case of interference with the refrigeration system). Otherwise, there may be a danger to health and life.
- 2) The staff is obliged to act in accordance with the applicable rules of occupational health and safety.
- 3) Electronic and electrical work may be performed only by authorized personnel.
- 4) Service work can only be carried out through the pump manufacturer's service team or external service on behalf of the manufacturer. Otherwise, you risk losing the warranty.
- 5) Note that the air for the heat pump is drawn from the rear of the unit, while it is blown out by the unit's fans. This implies the need to exercise every care in the correct positioning of the outdoor unit outside the building.
- 6) Follow the distances shown in Table 9 to ensure sufficient airflow and allow for maintenance work.
- 7) Make sure there is enough space for the installation of heating cables.
- 8) The heat pump is suitable for both ground mounting. Installation on a flat roof is possible, but check the current building and ceiling strength regulations. Adequate condensate drainage must be provided. Do not install the product on wooden-framed buildings and lightweight roofs. Installation on a sloping roof is not allowed.
- 9) The air temperature at the outlet is about 5°C lower than the ambient temperature. Therefore, under certain weather conditions, this can cause ice formation. Therefore, do not choose a location where the air outlet is near sidewalks, paving surfaces and drain pipes. Keep the heat pump at an appropriate distance from the ground.
- 10) Do not expose the outdoor unit to polluted, dusty and corrosive air.
- 11) Maintain clearance from vents.
- 12) Maintain distance from trees. Leaves can contaminate the heat exchanger of the heat pump and cause it to stop or be damaged.
- 13) Pay attention to noise emissions. Choose a place that is easily accessible from the point of view of carrying out maintenance work.
- 14) Avoid sucking in the air blowing out of the heat pump outlet.
- 15) Ensure that water does not collect on the ground, water must penetrate into the ground without obstruction.
- 16) Choose a place where large amounts of snow do not accumulate in winter. If this is not possible, remove snow regularly from the air inlet/outlet grille and around the product.
- 17) Choose a location where high winds do not affect the heat pump, especially the air intake. If possible, position the unit transverse to the main wind direction.
- 18) The location of the equipment must be below 2000 m above sea level.
- 19) Safety area:
Due to the fact that the product contains R290 refrigerant. The installation site must be at least 1m away from potential ignition sources: electrical switches, lighting switches and lighting. .

4.2. Location of the pump in relations to noise emission

The comfort of an air heat pump, both for the owner and the close environment, comes down to the noise emissions during its operation. In the case of an air heat pump, the operation of the fans has a significant impact on sound emissions, which directly determines the location of the outdoor unit. Sound emission values are determined outside the building, at a distance of 0.5 m from the center of an open window.

4.3. Transportation

It is imperative that the heat pump be transported individually and in an upright position as marked on the package. It is absolutely forbidden to tilt the heat pump more than 45°. The heat pump can be transported using a transport cart or by hand. When transporting, take special care not to damage the unit. Due to the sharp edges present, persons performing transportation are required to use protective gloves. Upon delivery to the installation site, check the model name and serial number of the units. The unit must always be stored in an upright position and be protected from moving. Failure to comply with the above recommendation will result in **loss of warranty**.

4.4. Unpacking the product

Before unpacking the device, carry out a visual inspection to check for any damage to the transport packaging. Particular attention should be paid to cracks and bulges in the box. The main activity after unloading the equipment, is to check whether the equipment was not damaged during transport. If a defect is detected, a damage report should be written in the presence of the driver with its confirmation on the document. Any damage noticed during the unpacking of equipment should be immediately reported to the transport company and the service department.

4.5. Storage

Unit should be stored in its original packaging, at temperatures between -35°C and 50°C and protected from corrosive weather conditions.

4.6. Mechanical installation and mounting

- 1)  When installing a heat pump, it is imperative to use protective equipment and personal protective clothing!
- 2) The heat pump must be installed with vibration-damping rubber dampers on a stable and rigid base that provides adequate strength under the load of the unit.
- 3) In order to ensure proper operation of the heat pump, it should be placed in a place with low dust, providing the least possible corrosive conditions, which ensures proper air circulation and safe opening of the unit. The ambient temperature at the installation site should not exceed +43°C.
- 4) The connection to the power grid should be made by an electrician with current electrical licenses.



4.6.1. Setting up the outdoor unit – general guidelines

- 1) In order to ensure adequate airflow to the outdoor unit, it is recommended to install it in an open space.
- 2) The unit must be installed in a way that prevents recirculation of outside air.
- 3) It is not recommended to install the unit near the bedroom or living room due to the generated noise.
- 4) The unit should not be installed in an area with flammable, volatile and corrosive substances.
- 5) The outdoor unit absolutely must have an adequate drainage system.
- 6) It is recommended to install the device with an eave or the use of a special canopy to protect the supply and cooling pipes from rupture caused by precipitation, such as falling snow.
- 7) Due to the run-off condensate, it is not recommended to install the device over the sidewalk or other traffic rows, where a risk of icing can occur.
- 8)  The minimum distances between the device and other partitions must be strictly adhered to. The unit is not suitable for the installation in areas, where a water spray may be used.
- 9) When installing on a flat roof, do the following:
 - a) protection of the unit against wind:
 - the inlet side through construction,
 - the outlet side cannot be exposed to wind,

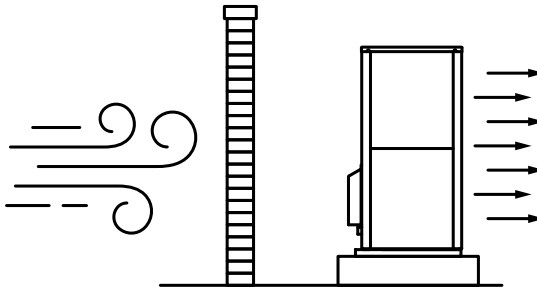

Fig. 15. Wind protection

- b) avoid installation in places where large amounts of snow, water, sliding ice and snow accumulate,
- c) perform the drain in a way that will not cause the outflow from the tray to freeze.

4.6.1.1. Ground mounting guidelines

- 1) Prepare the foundation in accordance with local conditions:
 - dig a hole in the ground,
 - insert draining pipe for the condensate drainage (10K f100, for 15K f160),
 - pile up a layer of coarse gravel.
- 2) Construct two foundation footings.
- 3) Make a gravel base between the foundation footings.
- 4) Level the unit at all points.

Required mounting distances of the pump on the ground:

MINIMAL DISTANCE	VALUE [mm]
A	400
B	600
C	1000
D	1000
E	1000
F	300

Tab. 8. Minimal recommended distance for ground mounting.

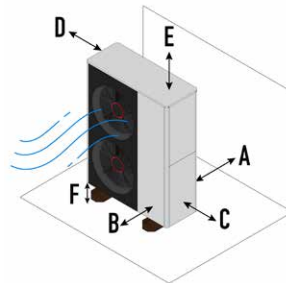
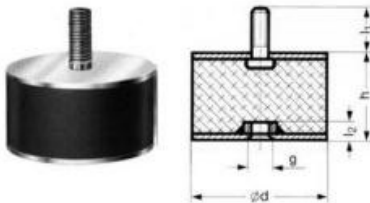

Fig. 16. Layout of the heat pump outdoor unit for ground mounting.

In order to set the outdoor unit on the ground, use:

- a) Rubber feet (included), rubber base optional



b) Stand

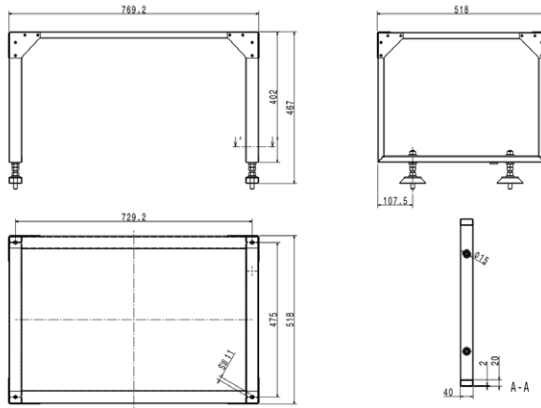

Guidelines for setting the heat pump on the ground are presented in Fig. 17

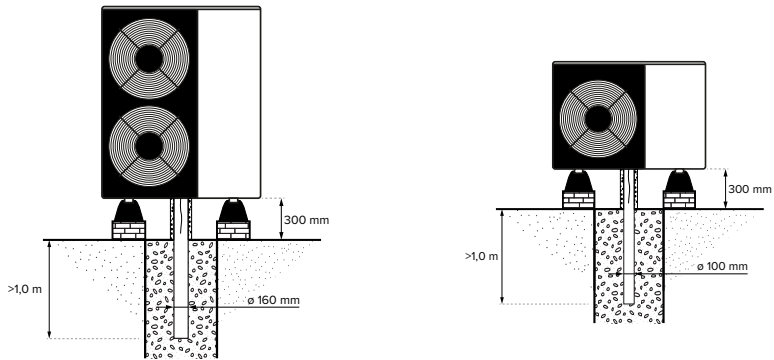
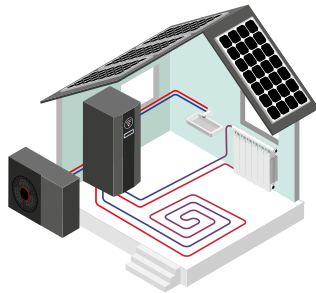

Fig. 17. Guidelines for mounting the heat pump outdoor unit on the ground on rubber feet.

4.6.1.2. Connecting the outdoor unit to the indoor unit

- 1) After mounting the outdoor and indoor units, look for the nearest place in the wall to make a hole. It is recommended that the hole be characterized by the best water resistance.
- 2) After determining such a place in the wall, drill a hole with a diameter of 50-100 mm.
- 3) After making the hole, you need to run two pipes through the wall. Be sure to properly insulate the hole with thermal insulation, such as insulating foam.



4.7. Defrost mode

When the pump is operating at temperatures below about 7°C at the set load, frost (icing) may appear on the exchanger. This is because, a large amount of water vapor present in the environment (the so-called humidity) during forced air flow through the exchanger is gradually deposited on the frozen lamella block. The melting of frost is accomplished by the same “compressor” system, or more precisely by changing the direction of refrigerant circulation. The energy required for this is taken from the heating system. The defrosting mode is carried out automatically at strictly defined periods and only when the heating mode is used.

Necessary conditions to start the defrosting process:

- 1) Evaporation temperature is below the value determined by the controller algorithm.
- 2) Ambient temperature is below 7°C.
- 3) Defrost interval exceeds the set value (default 45 minutes).

In JBG^{HT} brand heat pumps, the outer surfaces of the evaporator are covered with a hydrophilic coating, which shows excellent water protection properties in high temperatures and salty environments. The solution used consolidates water molecules, which in larger amounts under their own weight flow faster into the drip tray, the end result being the reduced defrosting time.

4.8. Electrical installation

4.8.1. Requirements

The device is designed to be powered from the electricity grid:

- 1) Power supply cables and power circuit protection should be selected to meet the condition of automatic power outage..
 - a) 1-phase: ~230 [V]/50 [Hz] L + N + PE
 - b) 3-phase: ~400 [V]/50 [Hz] 3L + N + PE
- 2) Power cables should be appropriately selected due to the length of the power lines and the characteristics of their routing:
 - a) 3-phase min. 5 x 4 mm²
 - Protection, overcurrent circuit breakers for the unit:
 - a) ZHHH-P1-010K-R290-R5-M: 20 A characteristics B, 1-phase, L + N
 - a) ZHHH-P1-006K-R290-R5-M: 16 A characteristics B, 1-phase, L + N
 - b) ZHHH-Z1-010K-R290-R5-M: 16 A characteristics B, 3-phase, 3L + N
- 3) it is required to use residual current protection in accordance with applicable standards.
- 4) In a 3-phase pump, select the number of heating circuits needed to meet the total demand.
- 5) Also check whether connecting the heater will not overload a single circuit.
- 6) The device is supplied with electrical voltage hazardous to life.
- 7) All work related to the repair and service of the device must be performed by personnel with the appropriate authorizations.
- 8) Before starting the device, check the device for damage, especially cables and electrical apparatuses.
- 9) The detection of any damage to the equipment will result in the prohibition of its commissioning and operation.
- 10) When making an electrical connection, the technical conditions for connection to the power grid shall be observed.



- 11) The electrical connection ratings must match those on the equipment nameplate.
- 12) The electrical cables and protection used, as well as the execution of the electrical connection, must meet the requirements of standards and local regulations.
- 13) Electrical cables must be suitable for outdoor use in suitable conditions.
- 14) Improper selection of power cable may lead to damage to the unit and may be a danger to the environment.
- 15) An improperly made electrical connection can cause electrocution and, during operation, cause damage to the unit, electrical system or lead to significant property damage.
- 16) When connecting the device to the power grid, make sure that the electrical voltage of the connection is turned off and protected against uncontrolled switching on.
- 17) Properly prepare and plan the installation of the unit and the electrical system.
- 18) Connect the electrical connection to the terminals of the unit in accordance with the electrical diagram of the unit.
- 19) After connecting the device to the power grid, take appropriate electrical measurements and draw up a measurement protocol.
- 20) Control wires and sensors should be routed at a distance of min. 100 mm from the power wires.
- 21) Modbus network cables may not be extended.
- 22) Ensure the correct order in which the compressor power phases are connected. Otherwise, the compressor may be damaged.
- 23) It is forbidden for the customer to alter the electrical circuit.
- 24) Required cable cross-sections

Types of wires	Phase / Wire cross-section
Connector X2 (pink)	
Cable	4 x 0,5 mm ²
Connector X1 (grey)	
Cable	5 x 0,25 mm ²
Power connector (black)	
1-phase	3 x 2,5 mm ²
3-phase	5 x 4 mm ²

Tab. 9. Types, phase and cross-section of wires.

22) Connection of the outdoor unit with the indoor unit:

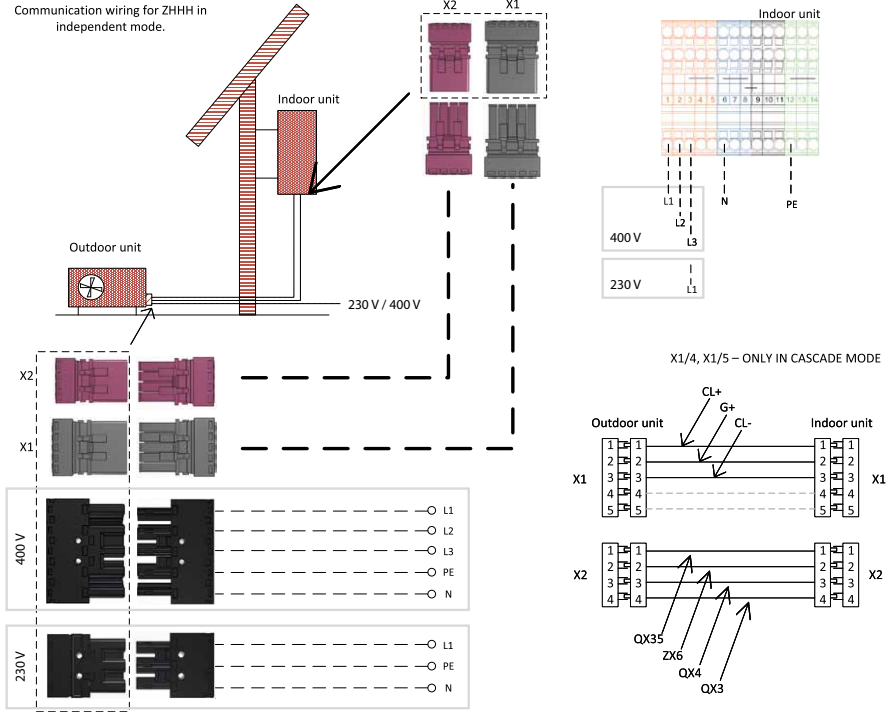

Fig. 18. Electrical installation diagram between the outdoor and the indoor unit



4.8.2. Installation diagrams

4.8.2.1. Electrical installation diagram 3-phase electrical system in the outdoor unit

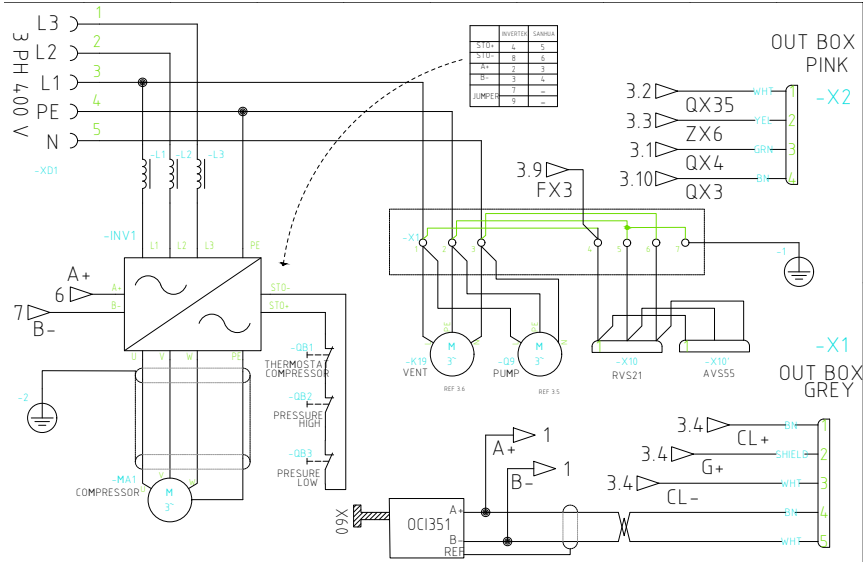

Fig. 19. Outdoor unit electrical installation diagram

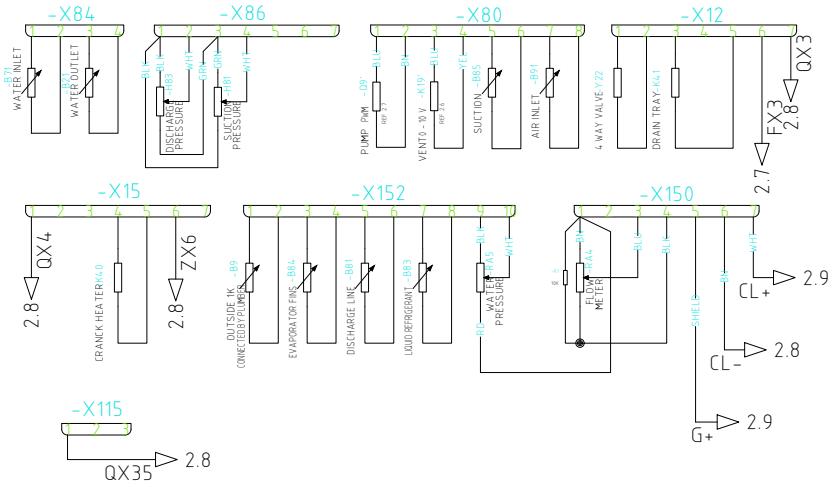

Fig. 20. Outdoor unit probes, transmitters and actuators connection diagram

4.8.2.2. 3-phase indoor unit electrical installation diagram

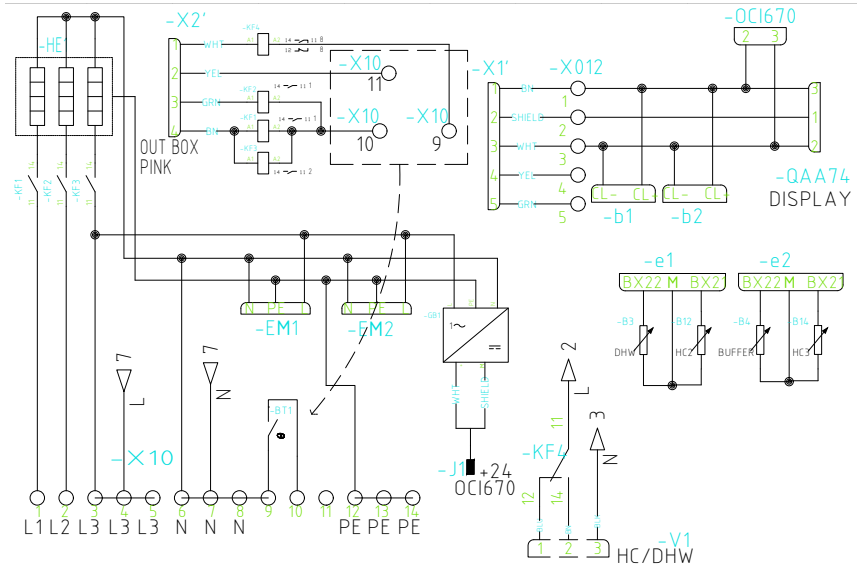

Fig. 21. Indoor unit electrical installation diagram

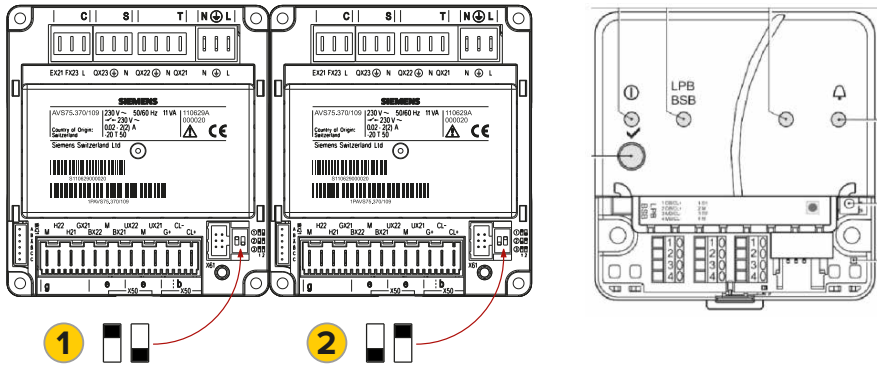

Fig. 22. Indoor unit coding diagram



Default suggested configuration

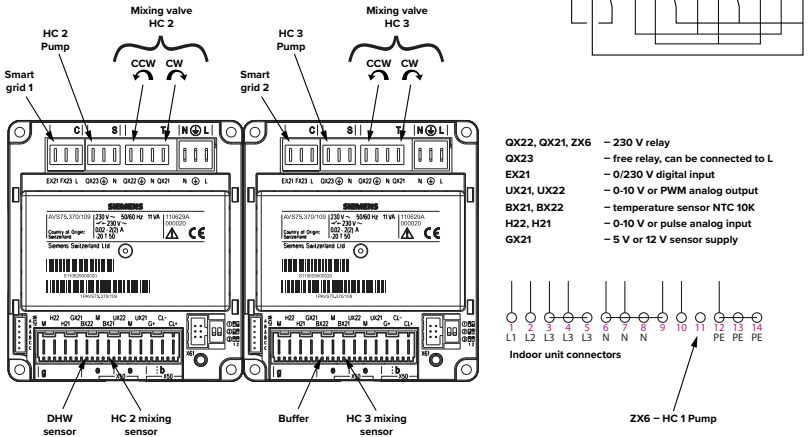

Fig. 23. Expansion module connection diagram

4.8.2.3. Thermal protection

Thermal protection of the automatic heater protects the water from boiling (default setting – 70 degrees).

4.9. Hydraulic system

4.9.1. Requirements

- 1) Pipes used in the heating circuit must be thermally insulated. The insulation must be resistant to UV as well as high and low air temperatures.
- 2) Connect the water return and supply of the heat pump as presented in Fig 28.

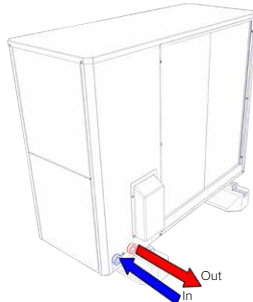

Fig. 24. Heat pump supply and return connections.

- 3) Before connecting the heating system to the indoor unit (hydrobox/hydrtower) of the heat pump, it should be flushed thoroughly to remove possible residues in the pipes.
- 4) Install a magnetic dirt filter on the pipeline at the point where the heating circuit returns to the heat pump. If the heat pump is installed at the highest point of the heating circuit then additional vent valves should be installed at these locations. After venting the system, turn off the vents in the system and in the heat pump.
- 5) Drainage of condensed water must be provided by a pipe with a minimum diameter of 100 mm for 10K and 160 mm for 15K. It is permissible to use a drain inserted vertically into the ground for a minimum of 90 cm, if the ground is permeable to water.
- 6) Pipe dimensions:

Dimensions of CH piping

Heat pump	Copper pipes	Steel pipes	Polypropylene pipes	Max. flow	Min. flow
ZHHH-P1-010K-R290-R5-M	28 x 1	32 (5/4")	32 x 4,4	1,68 m ³ /h	0,54 m ³ /h
ZHHH-P1-006K-R290-R5-M	28 x 1	32 (5/4")	32 x 4,4	1,68 m ³ /h	0,54 m ³ /h
ZHHH-Z1-010K-R290-R5-M	28 x 1	32 (5/4")	32 x 4,4	1,68 m ³ /h	0,54 m ³ /h

Tab. 10. CH pipe dimensions

- 7) A CH buffer is recommended in thermally upgraded facilities.
- 8) Recommended methods against freezing:

A. Use propylene antifreeze throughout the system to -7°C . Increase the flow rate by 10% on the circulation pump. Glycol concentration must not exceed 35%.

! B. Use of a system with manual removal of water from the exchanger. Two drain valves in the form of shut-off valves should be installed in the building to remove water from the exchanger by gravity. Additional two shut-offs to prevent the removal of water from the rest of the system. Heating cables between the heat pump and the building must be inclined at least 4 degrees to enable emergency water outflow. If frost protection is not implemented, the device may be damaged.

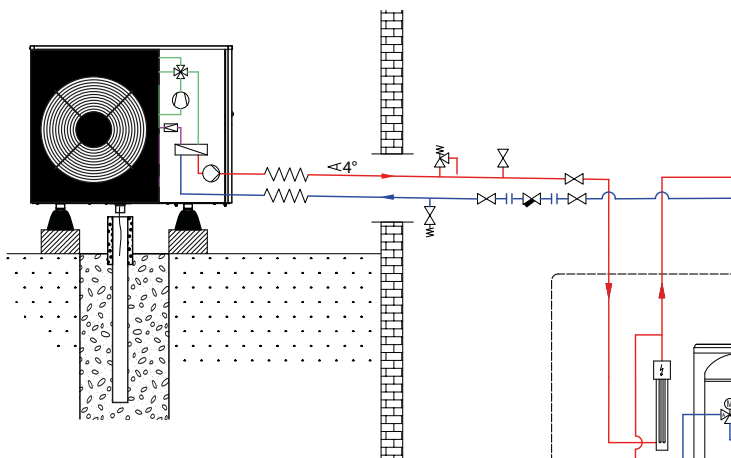

Fig. 25. Antifreeze protection.

4.9.2. Hydraulic system diagrams

Description of marked parts in hydraulic system diagrams.

1	Outdoor unit
2	Hydrotower/Hydrobox
3	DHW tank
4	Buffer tank
5	Circulation pump
6	Electric heater
7	Safety valve
8	3-way valve
9	Vent
10	Shut-off valve
11	DHW diaphragm vessel 25l
12	CH diaphragm vessel 12l
13	Non-return valve
14	Mesh filter (for tow and other non-magnetic debris)
15	Pressure relief valve
16	2in1 filter: magnetic separator + mesh filter (if using only the magnetic separator, add a mesh filter)
17	Proportional relief valve

Tab. 11. Description of marked parts in hydraulic system diagrams

4.9.2.1. Diagram of hydraulic system with parallel buffer (central heating + underfloor heating)

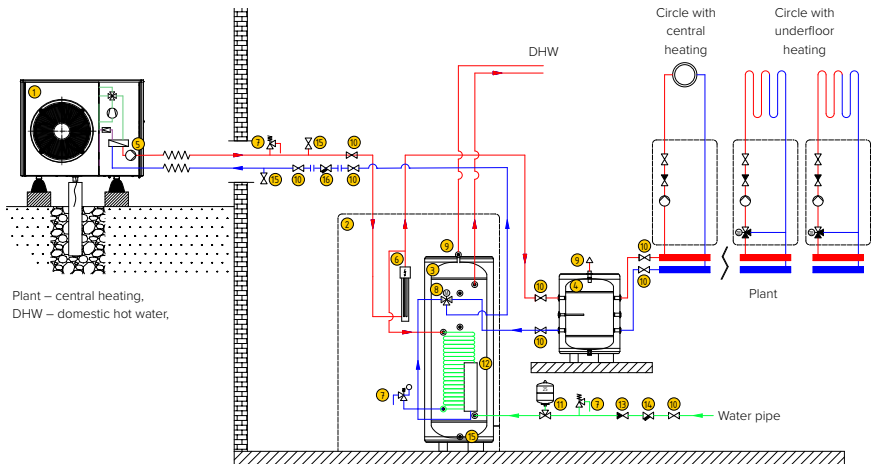

Fig. 26. Diagram of hydraulic system with parallel buffer (central heating + underfloor heating)

4.9.2.2. Diagram of hydraulic system with series buffer (underfloor heating)

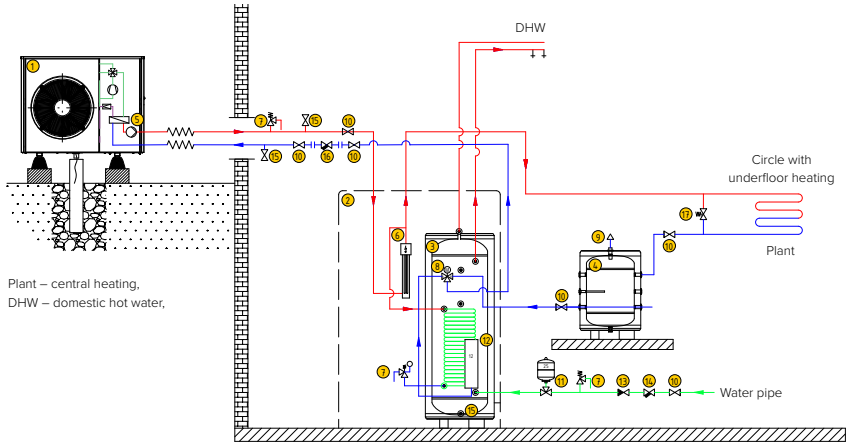

Fig. 27. Diagram of hydraulic system with series buffer (underfloor heating)

4.9.2.3. Diagram of hydraulic system without a buffer (underfloor heating)

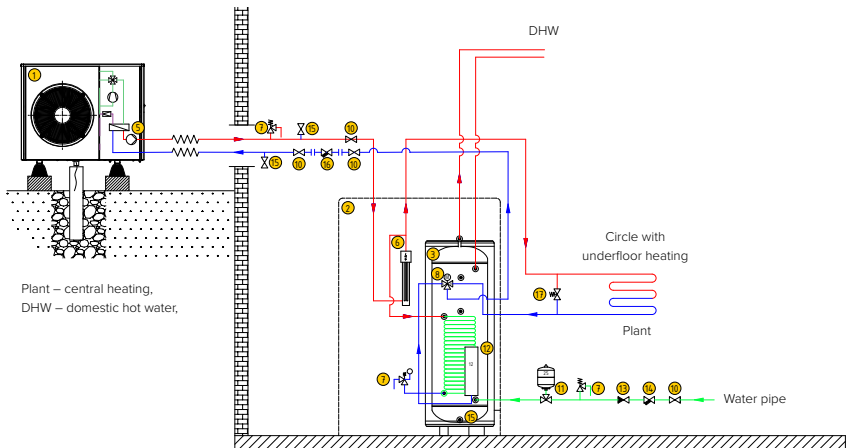

Fig. 28. Diagram of hydraulic system without a buffer (underfloor heating)



4.9.2.4. Hydraulic system diagram hydrobox option

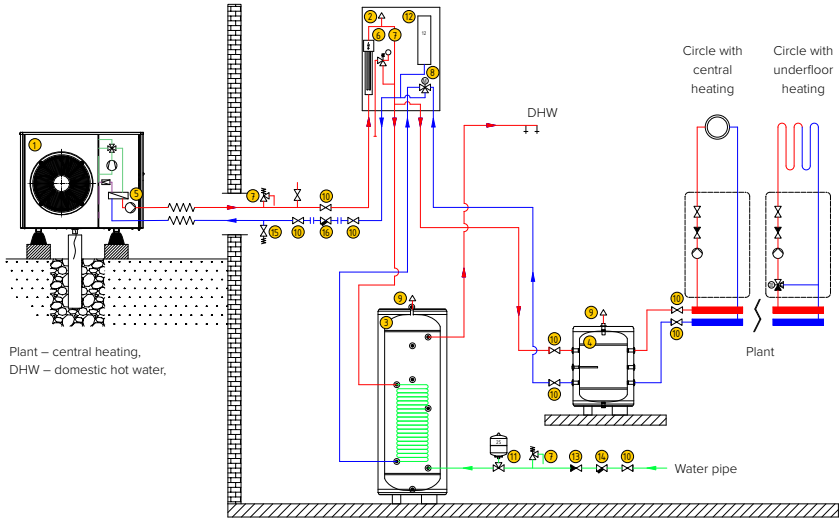

Fig. 29. Diagram of hydraulic system with a buffer (mixed heating)

4.9.2.5. Detailed diagram of Hydrobox module

1	Diaphragm vessel
2	Electric heater
3	Safety thermic
4	Automatic vent
5	3-way valve
6	Manometer – safety group
7	Power supply from PC
8	CH power supply
9	DHW power supply
10	CH return
11	HP return
12	DHW return
HP	Heat pump
DHW	Domestic Hot Water
CH	Central heating

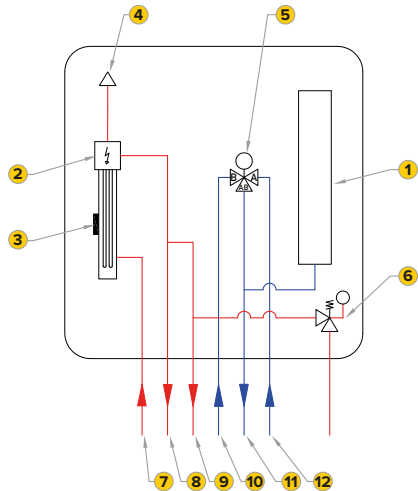

Fig. 30. Hydrobox hydraulic diagram

4.9.2.6. Detailed diagram of Hydrotower module

1	200 l DHW Tank
2	Diaphragm vessel
3	Electric heater
4	Safety thermic
5	3-way valve
6	Manometer – safety group
7	DHW drain valve
8	Anode
9	DHW temperature sensor
10	Power supply from PC
11	CH power supply
12	CH return
13	HP return
14	Domestic Hot Water
15	DHW circulation
16	Cold water supply mains
HP	Heat pump
DHW	Domestic Hot Water
CH	Central heating

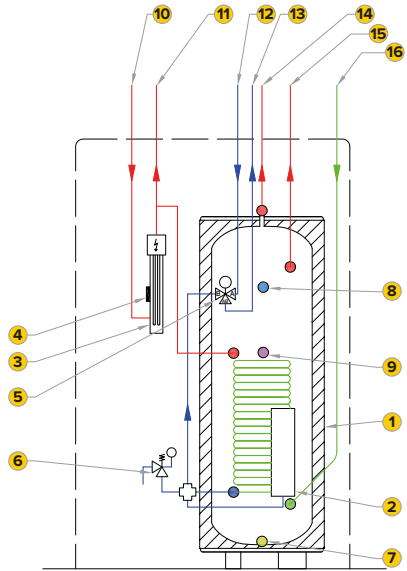
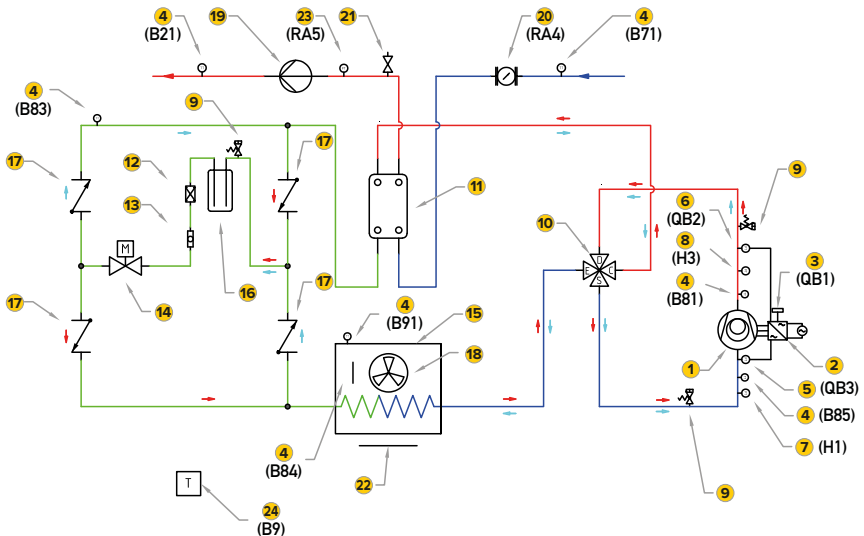

Fig. 31. Hydrotower hydraulic diagram

4.9.3. Diagram of the refrigeration system



1 Compressor	13 Speculum
2 Inverter	14 Electronic expansion valve
3 Thermostat	15 Evaporator
4 Temperature sensor	16 Water tank
5 Pressure switch	17 Service valve
6 Pressure switch	18 Fan
7 Pressure transducer	19 Circulation pump
8 Pressure transducer	20 Flow sensor
9 Service valve schreder	21 Automatic air vent 1/2" GZ
10 4-way valve	22 Drain tray heater
11 Plate exchanger	23 Pressure transducer for water (0-10 bar)
12 Filter drier	24 Outdoor temperature sensor

Fig. 32. Refrigeration system diagram

4.9.4. Water supply system

Before filling or any subsequent refilling of the system, make sure to check the quality of the water in the heating system:

- Visually check the water for precipitation of other materials. If this occurs, the user is required to clean the system.
- Use only demineralized heating water or water that complies with the VDI 2035 standard. Failure to do so may result in a decrease in the efficiency of the device and even damage to its components.

Desliming of the system is not included in the installation and commissioning of the heat pump. The installation should be de-sludged before installing the heat pump and before starting it for the first time.

- Check with a magnetic rod whether magnetite (iron oxide) is present in the water. If found, treat the water accordingly.

In the case of an existing installation, clean the system and install a magnetic filter.

- Check the pH value of the water at a temperature of 25°C. Required pH 8.3-9.3

When treating filling water, comply with applicable national regulations and technical rules.

It is generally accepted that water should be treated if the values in Table 12 are not met.

Heating power	Water hardness in relation to the volume of the installation					
	$\leq 20 \frac{l}{kW}$		$20 - 50 \frac{l}{kW}$		$> 50 \frac{l}{kW}$	
kW	°dH	mol/m ³	°dH	mol/m ³	°dH	mol/m ³
< 50	< 16,8	< 3	11,2	2	0,11	0,02

Tab. 12. Recommended water hardness values

Unsuitable additives may pose a risk of material damage. This may especially apply to all types of seals. Cause harmful physical changes to parts. For this reason, antifreeze, corrosion inhibitors and sealants should not be used. The technical parameters of installation water should be checked during annual technical inspections of the heat pump and, if necessary, adjusted to the required values. If the water supply pressure from the network exceeds 3 bar, a reducer should be used, setting the value to 3 bar.

4.9.5. Filling up and venting the system

Fill the system with heating water. Slowly increase the filling pressure until the desired working pressure is reached. The working pressure should be between 1.5 and 2 bar. For filling, use a suitable cart with a tank and pump, which allows you to properly vent the installation. During filling, control the vent valves. When venting, check the pressure in the system. If the pressure drops, top up the water system. After filling and venting, activate the heating circuit pump on the controller. In the case of an open hydraulic system, fill the system until there is overflow in the hydraulic system expansion tank.

4.9.6. Installing the DHW sensor

An important step that goes into the first start-up procedure is to check the correctness of operation of the heat pump sensors. In a configuration with a DHW tank, one such sensor is the probe that measures the temperature of domestic hot water. It is important to install this sensor correctly. It should be placed halfway up the tank, inserting it inside the tank through the designated entrance. The location of the sensor is presented in Figure 33.

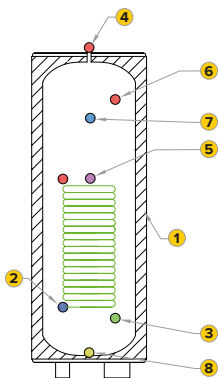

1	Tank
2	Coil
3	Cold water inlet
4	DHW inlet
5	temperature sensor
6	DHW circulation
7	Anode
8	Drain valve

Fig. 33. Location of the DHW sensor

4.9.7. Initial commissioning

The initial commissioning of the installation is performed by an authorised installer. During the first commissioning **THE HEAT PUMP ACCEPTANCE / COMMISSIONING REPORT**. Completed and signed by both the installer and the customer, including **Heat pump commissioning checklist**, **Installer declaration** and the first page of the **Warranty card**, shall be sent by the installer in the form of a clearly readable photocopy to the manufacturer at the e-mail address within 3 days from the date of the commissioning.

Scope of services for the first start-up performed by an authorized Installer:

- 1) Checking fan operation.
- 2) Checking the quality and tightness of the water supply system.
- 3) Checking the supply voltage of the unit.
- 4) Ensure that the unit is properly grounded.
- 5) Checking the correctness of operation of electrical safety devices.
- 6) Checking the quality of electrical connections.
- 7) Check for positive pressures in the system to verify that the system has been filled with refrigerant.
- 8) Check water and air temperatures to verify proper operation of heat pump sensors.
- 9) Turning on the heat pump.
- 10) Control of the obtained operating parameters of the heat pump.



- 11) Instruct the user on the basic operation of the heat pump.

The heat pump first startup service does not include installation activities such as:

- 1) Installation of heat pump units (routing of electrical and hydraulic cables)
- 2) Installation of accessories and electrical equipment (circulating pump sensors, electrical safety devices)
- 3) Filling and venting the system.

5. STARTING UP THE HEAT PUMP

5.1. User interface

The controller is operated using a setting knob, which also functions as a button. To select the correct parameter, turn the knob left or right and then press it.

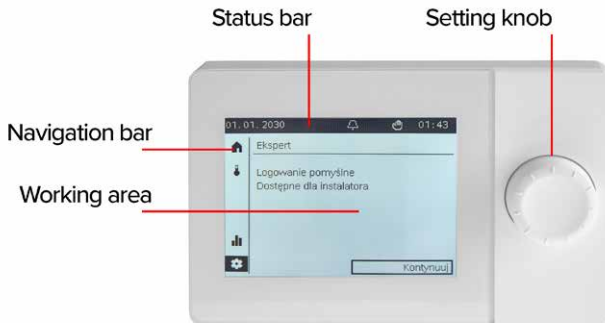

The display contains the following areas:

- Navigation bar to navigate between different options, such as: CH, DHW, Settings.
- Status bar displaying the pump status, such as: compressor status, alarm signal and date and time.
- The work area navigated with the controller.









5.2. Setting knob operation

To navigate the navigation bar:

- | | |
|---|--|
|  | Turn the setting knob: Pre-select the symbol in the navigation bar.
The related subject page is displayed in the work area. |
|  | Press the setting knob: Subject page selection.
The first adjustable operation site in the working area is preselected. |
|  | Return using the black arrow on the navigation bar. |

To navigate the work area:

	Turn the setting knob: Pre-select the operation site.
	Press the setting knob: Selection of the operation site.
	The lower level displayed when the operation site consists of several levels (such as a time programme).
	Set the value
	Confirm the set value.
	The set operation site is framed again (pre-selected).
	Continue navigation
	On the selected page title to navigate to other pages
	"Back" in the work area
	Black arrow returns to the navigation bar

5.3. Configuration of the operating device

The configuration of the operating device is the first step during the initial commissioning of the heat pump.

First, select the language

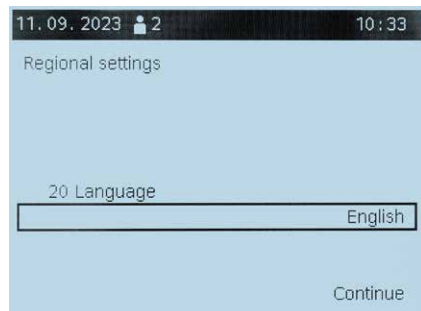

Then set the current date and time.

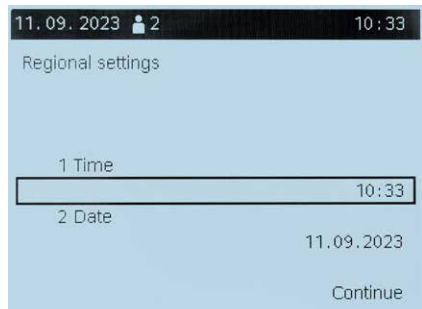

Assign the use of the operating device as **“Control panel 1”**

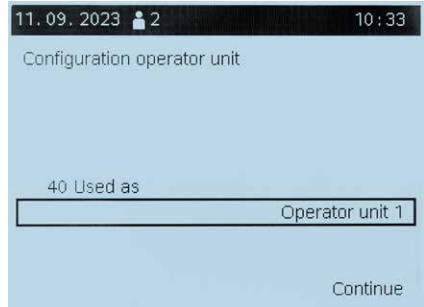

Assign the operating device to all zones.

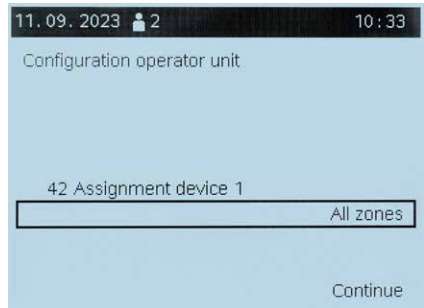

Set the operation of the other zones as **“independent”**.

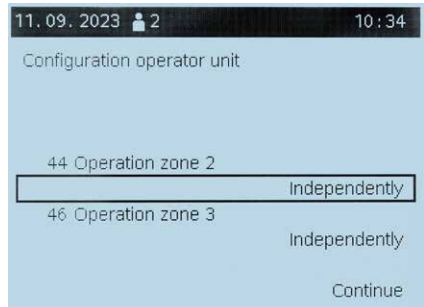

Assign the parameter below **“none”**.

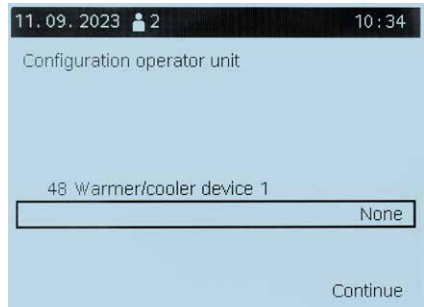

A notification of the completion of the operating device configuration will be displayed. If you want to change a parameter, select "Redo" to go through the configuration process again. The user can return to the configuration process of the control unit at any time from the controller menu.

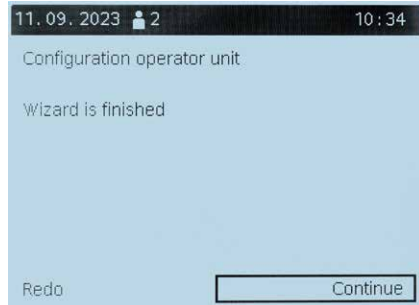

The operating device will be refreshed.

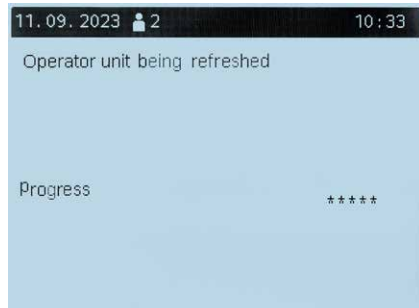

5.4. Initial commissioning

"Commissioning configuration" is a procedure that needs to be followed during the initial commissioning enabling the basic heat pump operation parameters to be set. The user will be able to return to this procedure at any time to change the previously selected settings. Click Continue.

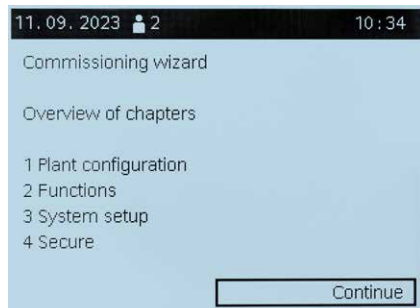

The first section is "Installation configuration". Click Continue.

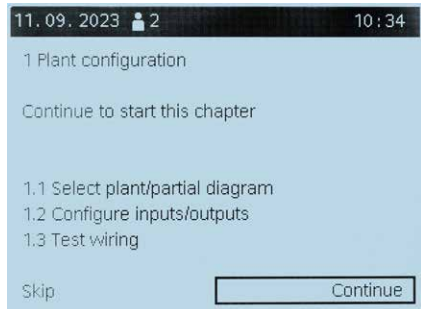

Select the preset to "not used" and click Continue.

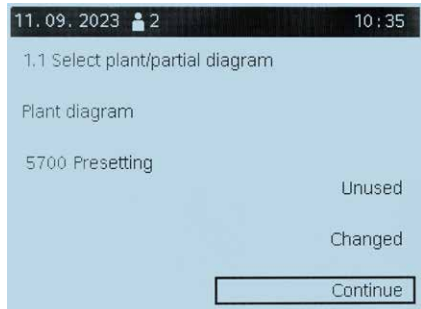

Switch on heating circuit 1 and click Continue.

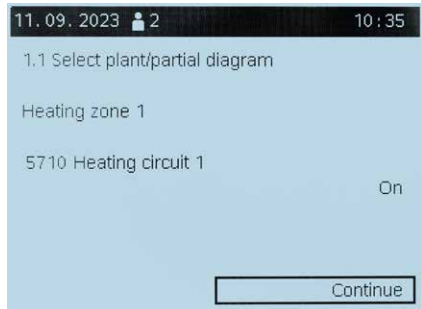

Select the 2-pipe cooling system and click Continue.

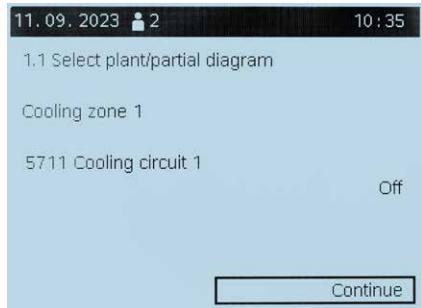

Assign the mixing valve the heating and cooling function and click Continue.

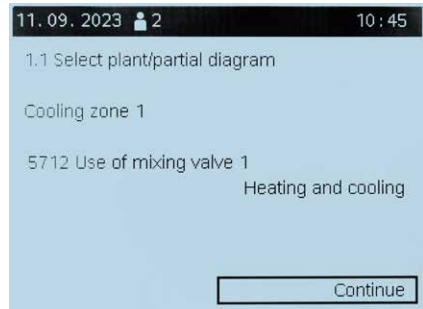

Afterwards two more independent heating and cooling circuits can be connected depending on the system layout. If you have only one heating and cooling circuit, switch off the other two and click Continue.

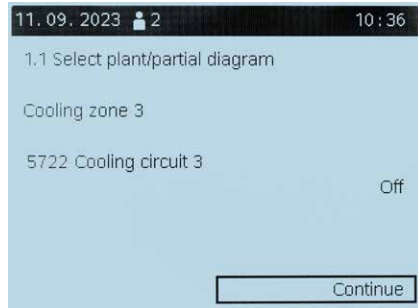
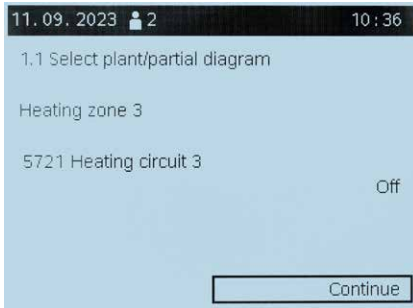
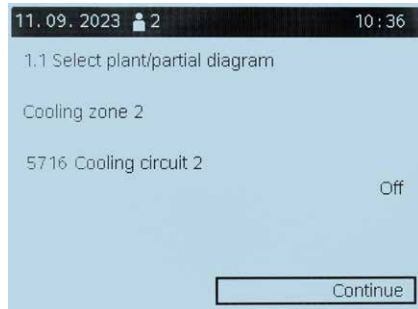
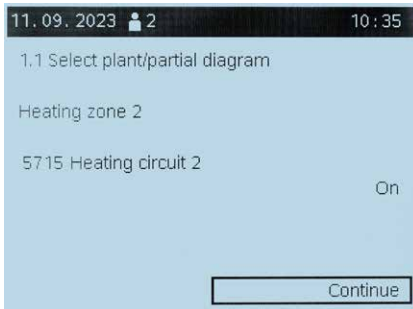

If a 3-way valve is installed in the system switching between heating and hot water mode, the DHW actuator is selected. Q3 as a diverter valve, switch off the separate DHW circuit and click Continue.

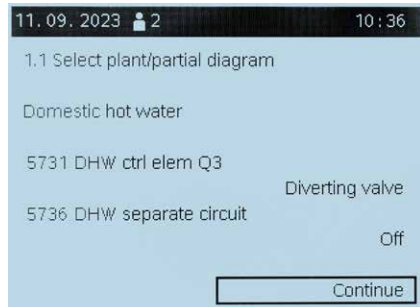

The receiving circuits are designed for industrial installations. Turn off both circuits and click Continue.

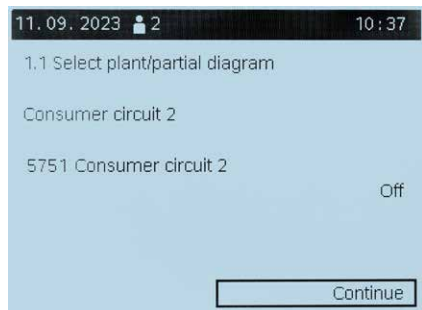
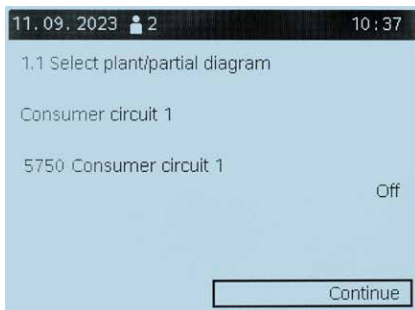

If the system is equipped with a buffer tank, it is necessary to choose – from the hydraulic aspect – whether the main controller or the system pump is installed after or before the buffer tank. When selected, click Continue.

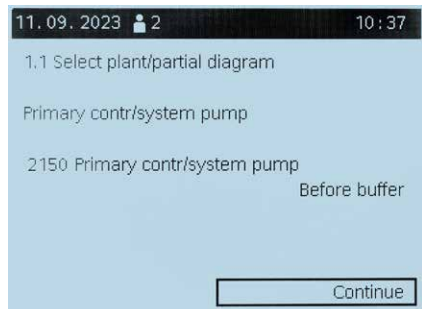

Select the 2-pipe cooling system. Currently, the cooling option remains disabled on ZHHH pumps. When selected, click Continue.

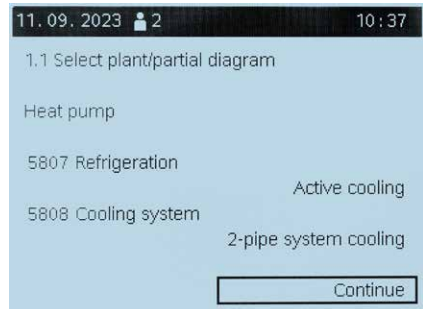

Select switching on the condenser pump with DHW while switching off in passive cooling mode.

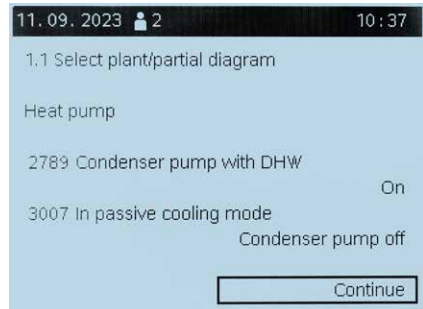

Instead of a collector pump and tank integration diverter valves, solar systems can also be operated with charging pumps. When using a diverter valve, the flow can only pass through one heat exchanger at a time.

Only alternating operation is possible. If a charge pump is used, the flow can pass through all heat exchangers. Parallel or alternating operation is possible.

For solar systems with 2 tanks, choose whether the external heat exchanger is to be used for both the DHW tank and the buffer tank, or just one of them. When set, click Continue.

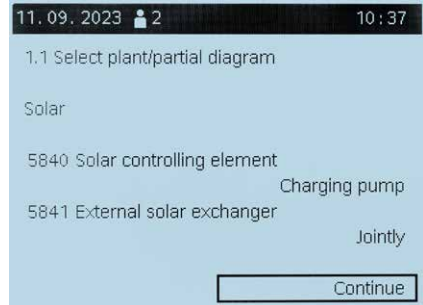

This section is complete, if you want to change a specific parameter, repeat the configuration steps by selecting “Repeat”, or click Continue to proceed.

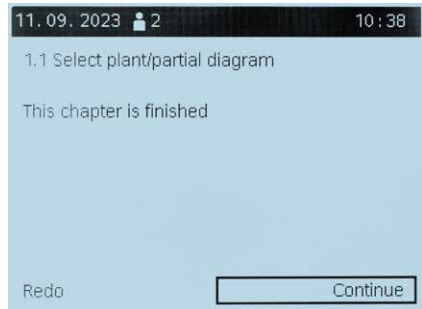

The input/output distribution should be ignored. These settings are assigned at the factory with the software and should not be changed.

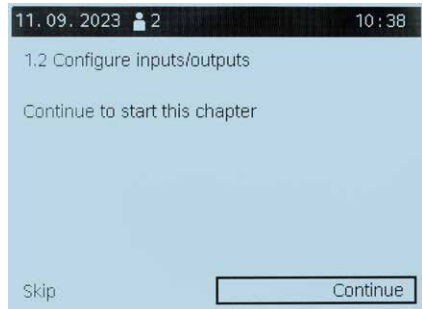

In this section, you can test the wiring and electrical connection and check the operation of the relays and temperature sensors. This section can be skipped if you do not need to check those.

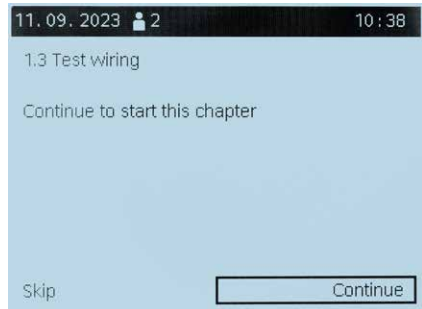

In the next section, you can select the heat pump functions. Click Continue.

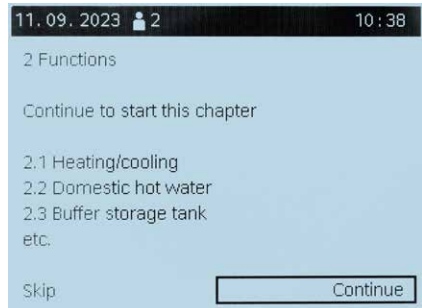

Depending on the number of heating circuits selected in the previous section, you can select the slope and offset of the heating curve for each circuit individually.

Significant differences in the slope lead to significant changes in flow temperature at low temperatures. If the room temperature is too low or too high only at certain outdoor temperatures, it is advisable to make a slight upward/downward adjustments to the heating curve.

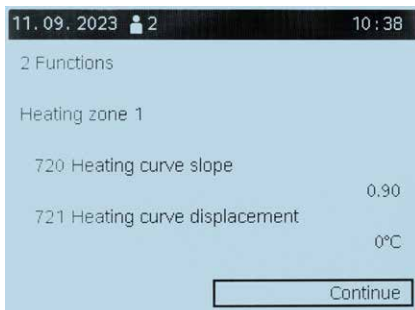

The parallel displacement of the heating curve results in an overall change in the outlet temperature of the medium over the entire range of external temperatures. If the room temperature is always too high or too low, it is recommended to use parallel displacement.

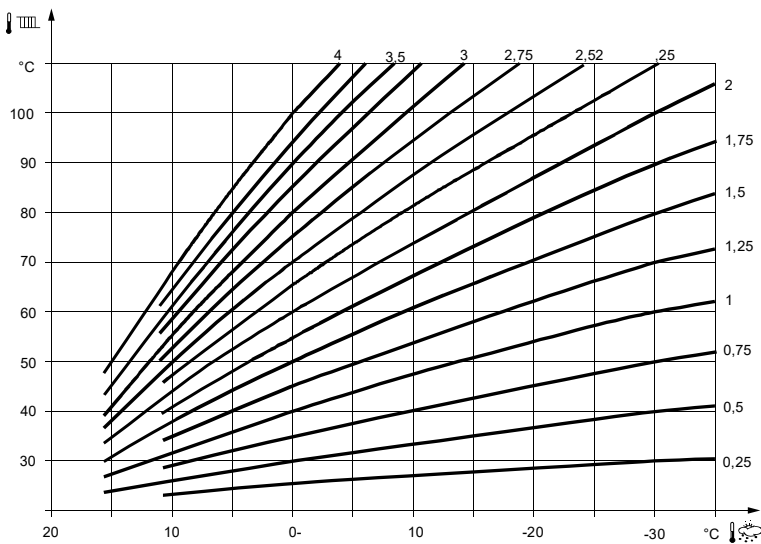

The corrected heating curve is based on a room temperature set point of 20°C. If the room temperature set point changes, the heating curve will be corrected automatically. When setting the heating curve, the type of building design (thermal insulation) and the type of installation must be taken into account.



If the adjusted outside temperature exceeds the “Summer/winter heating limit” (such as in spring), the heating system switches off. If the adjusted outdoor temperature drops (such as in autumn), heating will be switched on when the temperature falls to 1 kelvin below the temperature limit.

Setting the “24-hour heating limit” parameter sets a temperature limit. If the outside temperature exceeds this limit, the heating system will be switched off during the day.

If the adjusted outdoor temperature drops (such as in autumn), heating will be switched on when the temperature falls to 1 kelvin below the temperature limit.

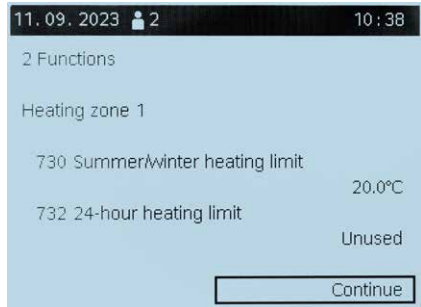

Set the minimum flow temperature to 20°C and the maximum to 65°C.

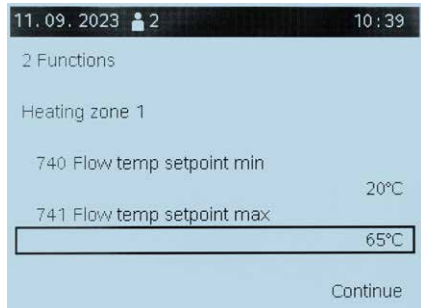

In the case of the room temperature impact parameter, the deviation of the current room temperature from the set point is checked and then taken into account when controlling the room temperature. The permissible deviation is set as a percentage. The better the conditions in the reference room (correct room temperature, correct mounting location, etc.), the higher the value can be set. For this function to work, the following conditions must be met:

- A room sensor must be connected.
- “Room impact” must be set to a value between 1 and 99%
- There should be no thermostatic radiator valves in the reference room (room sensor location); if installed, they must be fully open.

If the room temperature exceeds its current set point by more than the “Room temperature limit”, the heating circuit pump is switched off.

The heating circuit pump will restart when the room temperature falls below the current room temperature set point.

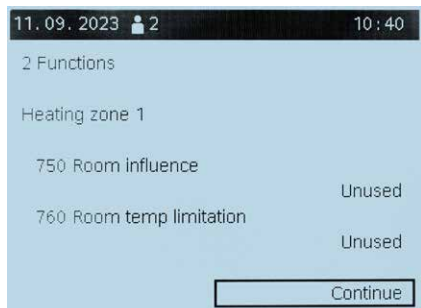

The cooling curve is determined by defining 2 fixed points (flow temperature set point at 25°C and 35°C).

Represents the flow temperature required for cooling at a corrected outside temperature of 25°C, without taking into account summer compensation.

Represents the flow temperature required for cooling at a corrected outside temperature of 35°C, without taking into account summer compensation.

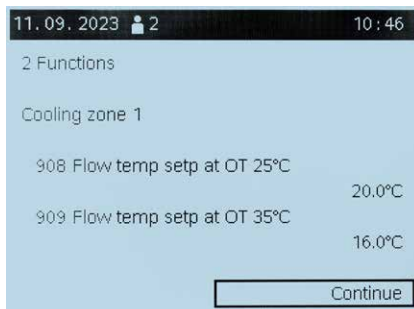

“Cooling limit at TZ” for cooling corresponds to “Summer/winter heating limit” (line 730) for cooling.

If the adjusted outside temperature exceeds the “Cooling limit at ZT” (such as at the beginning of summer), the cooling system will be switched on.

If the adjusted outdoor temperature drops (such as at the end of summer), the cooling system will be switched off when the temperature falls 0.5 kelvin below the temperature limit.

Setting the “24-hour cooling limit” parameter sets a temperature limit.

If the current outside temperature falls below this limit, the cooling system is switched off (such as at the end of the day).

If the adjusted outdoor temperature rises again (such as in the morning), the cooling system will be switched on again when the outdoor temperature reaches 0.5 kelvin above the temperature limit.

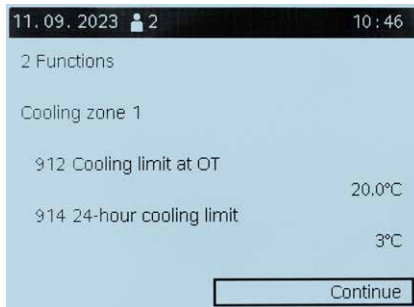

To avoid sudden a change to cooling at the end of heating, the “Cooling” function is locked for the period specified here. The locked period starts if there is no correct heat request from the heating circuit.

The same applies to the opposite case. To avoid sudden changes to heating at the end of cooling, the “Heating” function is locked for the period set here. The locked period starts if there is no correct cooling request from the cooling circuit.

The effect of room temperature is the same as in the case of heating.

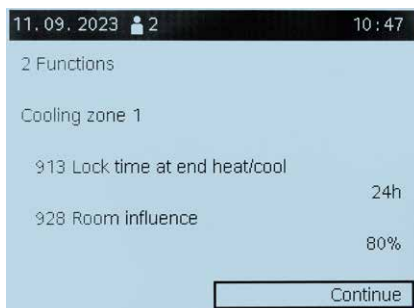

The DHW is heated according to the various set points. These points activate depending on the selected operating mode, leading to the required temperature level in the DHW tank.



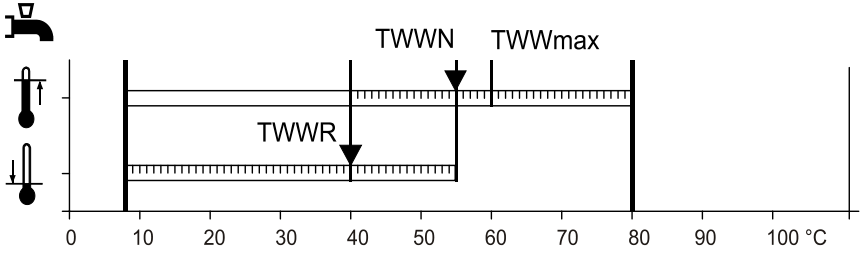

TCOPR Reduced DHW set point.

TCOPN Nominal DHW set point.

TCOPmax Maximum value of the nominal DHW set point.

24 hours a day

The DHW temperature is always maintained at the nominal DHW set point. (regardless of time programmes).

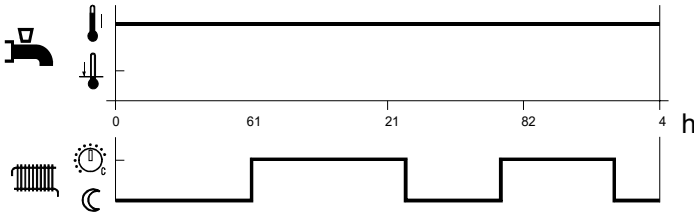

All HC/CC time programmes

The DHW set point changes between the nominal and reduced DHW set point according to the heating/cooling circuit time programme. The first switch-on point of each phase is moved forward in time by 1 hour.

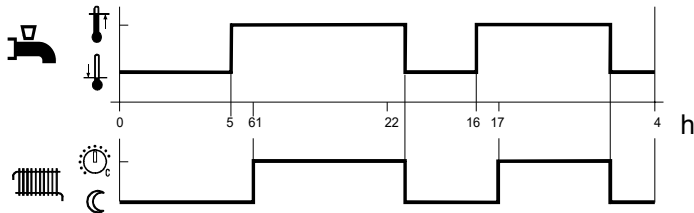

Time programme 4/DHW

DHW heating uses time programme 4 of the local controller. It uses the switching times set in this programme to change between the nominal and reduced DHW set points. In this way, the DHW tank is charged independently of the heating circuits.

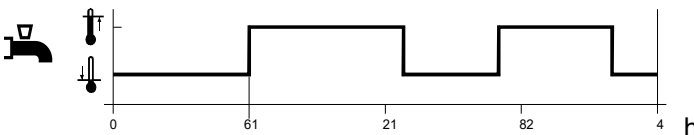

Low tariff

If the low tariff input (E5) is active, DHW heating is released.

Select the desired mode and click Continue.

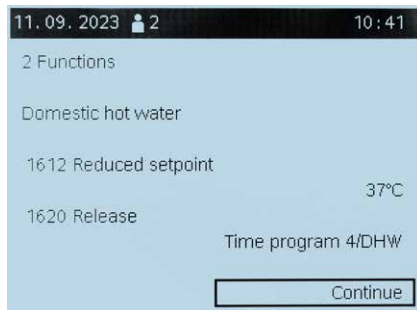

If the heating and DHW circuits demand heating at the same time, the “DHW priority” function ensures that when charging the DHW, heat generated by the heat source is used for DHW first. Select the desired priority and click Continue.

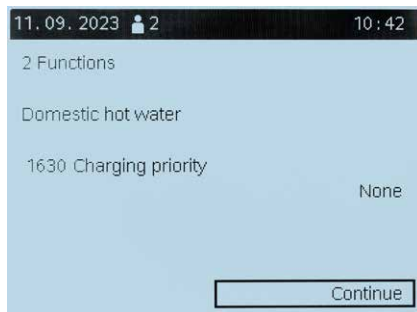

DHW tank is heated to the adjusted set point. Due to the possibility of the development of Legionella bacteria that are dangerous to health in the installation, ZHHH pumps have a thermal disinfection function, i.e. a single heating of hot water to a temperature of 60°C for a period of 15 minutes. During the first start-up, the installer should activate this function by selecting the periodicity interval of the function or a set day of the week and time (night hours are recommended). If no time is specified, this function will be performed the first time DHW is released or at midnight if it has not been released.

NOTE! Opening the water during the disinfection procedure and afterwards causes the risk of scalding.”

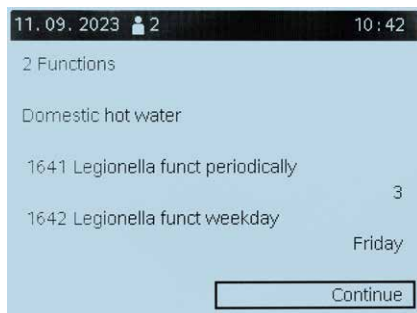
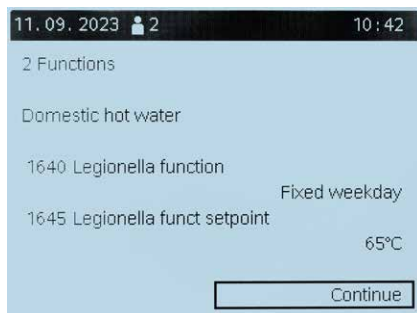

Specifies the times at which the silent mode is active.

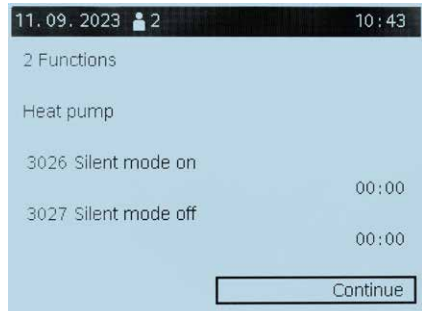

The „guided” pointer used as the set point for forced charging in heating mode may be limited by a minimum and maximum value. The „guided” pointer retrieves the maximum temperature request values from the heating circuit and stores them. Every day at midnight, the set point based on the „guided” pointer is reduced by 10%.

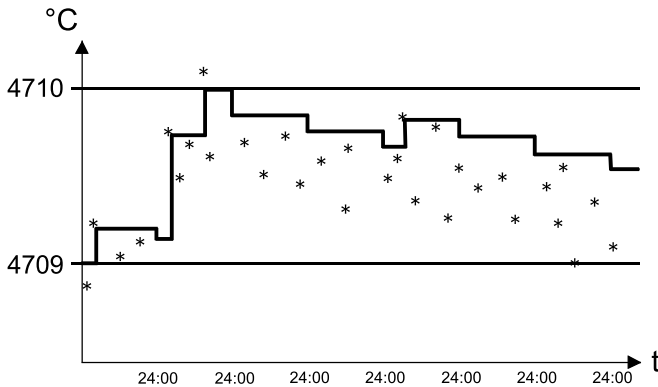
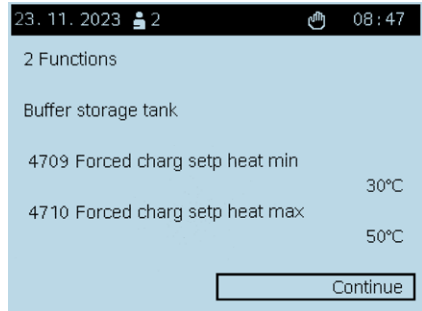

* = individual temperature requests
 4709 - Forced charging set point - minimum heat
 4710 - Forced charging set point - maximum heat

Forced charging starts every day at the time of day set here (00:00...24:00). The „- - -“ setting deactivates forced charging.

Forced charging is interrupted when the required set point has not been reached after the period set here has elapsed.

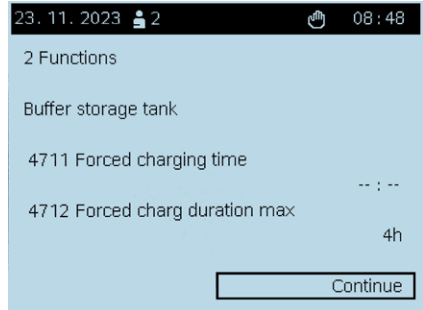

The temperature difference at an outdoor temperature of -10°C entered in this operating line is converted to the current corrected outdoor temperature. At an outdoor temperature of -10°C, the flow temperature set point is reduced by the set value. At an outside temperature of -20°C, reduction will no longer occur.

The flow temperature set point (according to the heating curve) is reduced by the expected temperature difference across the condenser and used as the return temperature set point.

Parameter 5810 is only active if there is no buffer tank.

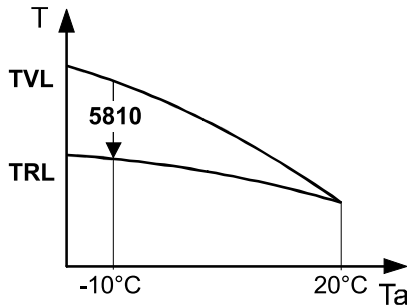
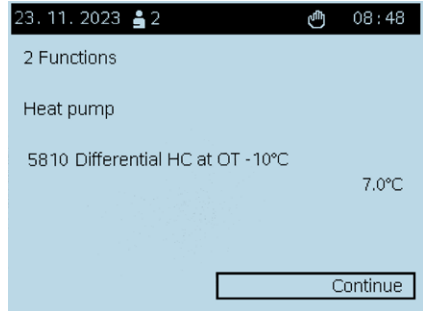

TVL Flow temperature
 TRL Return temperature
 Ta Outside temperature



This section is complete, if you want to change a specific parameter, repeat the configuration steps by selecting "Repeat", or click Continue to proceed.

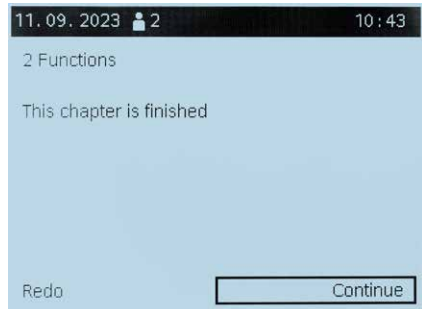

This section refers to the system communication and the assignment of the relevant pump numbers in the case of a cascading connection. It can be skipped.

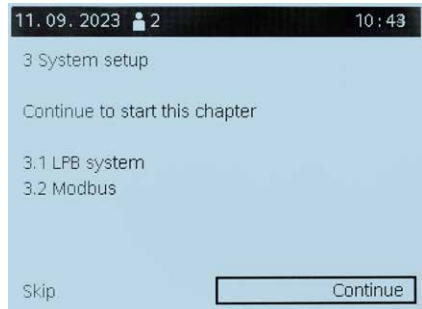

This section must be skipped.

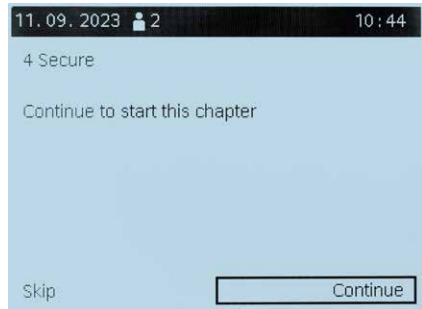

Choose whether you want to go through the configuration step again when restarting the heat pump.

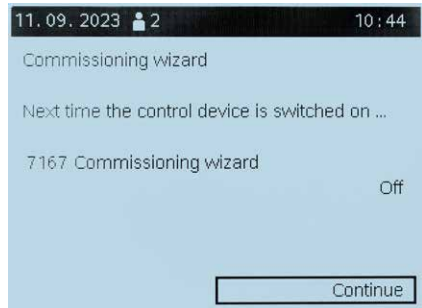

Once all parameters have been selected, the configuration tool will be terminated.



The device will be refreshed and after a moment the main screen of the controller will be displayed.

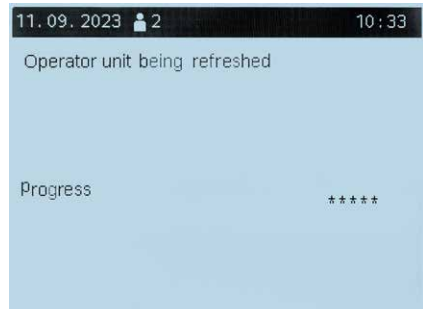

5.5. Controller main menu icons

Description of the individual controller symbols displayed in the navigation bar on the left.

Available in the User and Expert view:



Start page: Installation status. Access to the installation switch (or zone).



Temperature page. Access to heating and cooling.



Hot water side. Hot water preparation available.

Information pages:



- Messages (errors, events)
- Installation information
- Energy and consumption data timeline

Maintenance/setting pages:



- Setting the device or installation parameters
- Special mode operation (such as for maintenance)
- Logging in to the Expert view (see note below)

Additionally available for the Expert view:



Diagnostic pages: Analysis and checking of installations



Configuration and repairs:



- Parameter adaptation in the "Full parameter list"
- Access to commissioning guides

Description of the individual controller symbols displayed in the status bar at the top.



The "Alarm" symbol indicates an installation error



The "Maintenance/special mode" symbol indicates a maintenance message or special mode notification.



The "Event" symbol indicates an event message from the installation.



The "Hand" symbol is displayed when the setting of the installation/zone switch is altered by a change on the subject pages. The settings made on the subject pages can be restored using the installation/zone switch.

12:00

The unit's clock is synchronised with the connected controller's clock.



The "User" symbol and the number to the right (access level 1 to 3) indicate which user level is currently active.



The "Source" symbol indicates that the heat pump is currently on

5.6. Controller home screen

View of the controller's start page. The homepage provides a full view of the status of the installation. It includes such parameters as:

- Heat pump flow temperature
- Return temperature to the heat pump
- Outside temperature
- Temperature in the domestic hot water tank.



5.7. Heating/cooling side

View of the heating/cooling side of the controller.

On the heating/cooling side, you can select one of four operating modes:

- Protection – in this mode the heating system is switched off, but the room is protected against frost according to the parameter set in line 714.
- Reduced – in this mode the room temperature is maintained at the level set in line 712.
- Comfort – is the set point relating to the standard use of the room according to the parameter set in line 710.
- Automatic – the room temperature is controlled by the selected time programme.

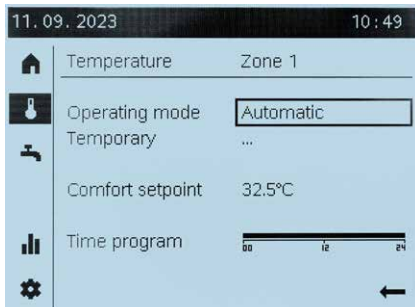

The “Temporarily” option allows the temperature to be temporarily adjusted to specific circumstances.

From this tab, you can also set the room temperature in comfort mode and the time programme.

5.8. Time programmes for heating/cooling

To activate the heating/cooling time programme, go to the heating/cooling page view of the controller and then select the time programme line. Time programmes can be set for each heating zone and are used to switch to a reduced temperature. They are only used in the automatic mode.

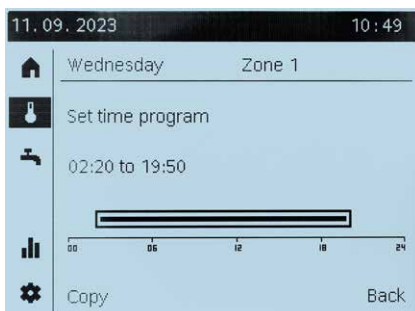
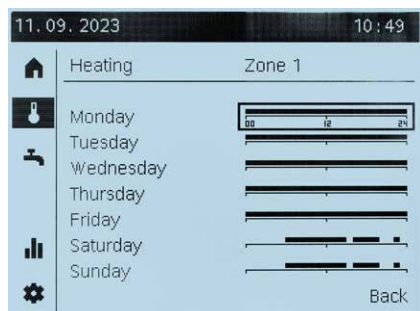
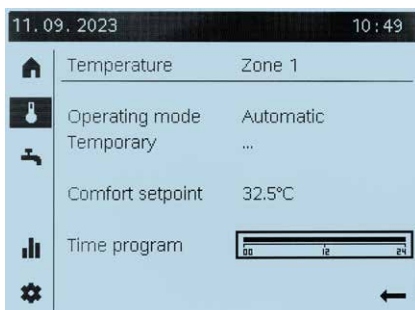

Select the desired day of the week. On any given day, you can set up to three time phases. Select “Add phase” and then specify the start and end of that phase.



5.9. Hot water side

View of the hot water side of the controller.

On the “domestic hot water” page, you can switch the DHW heating mode off or on and set the desired temperature.

The “Temporarily” option allows the temperature to be temporarily adjusted to specific circumstances.

Time programmes work similarly as in the case of heating (see section 3.8).

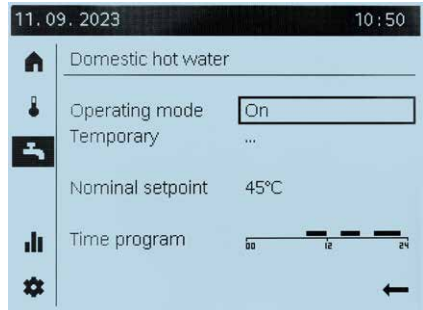

5.10. Information page

View of the controller’s information page. On the information page in the “Heat pump” tab, you can view in which mode the unit is currently operating and its supply parameters, as well as the set point values.

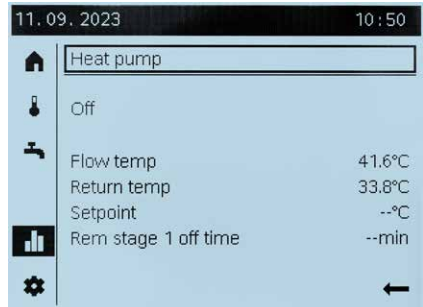

HEATING ZONE

In the “Heating zone” tab (the number of zones depends on how many are switched on), information is displayed in which heating mode the unit is currently operating and the current room temperature (requires a room sensor), the desired room temperature and the water supply temperature.

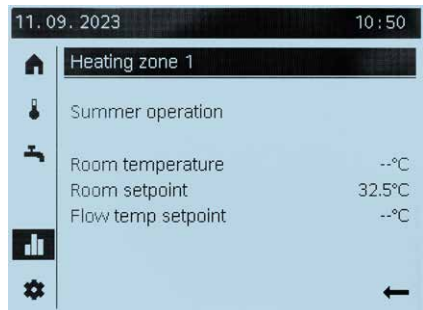

DOMESTIC HOT WATER

The “**domestic hot water**” (DHW) tab displays the current status of the mode and the temperature in the DHW tank.

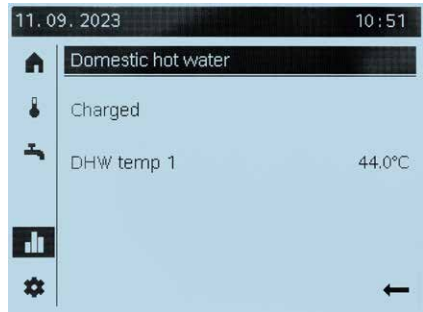

BUFFER TANK

The “**Buffer tank**” shows us the current status of the mode and the temperature in the buffer tank.

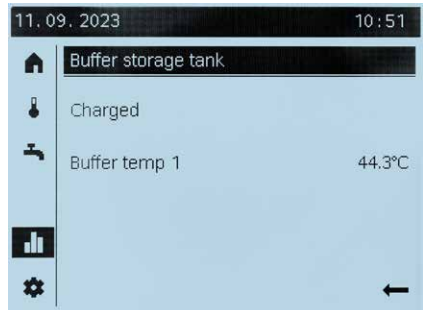

OUTSIDE TEMPERATURE

The current temperature outside.

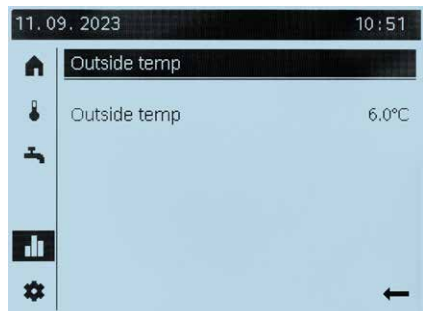

In the following tabs, graphs are presented graphically:

- heat supplied for heating.
- heat delivered for domestic hot water purposes.
- electricity consumed.
- the annual factor.

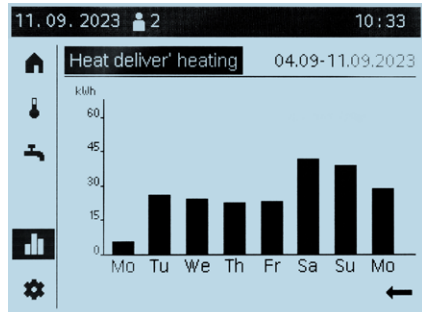

5.11. Maintenance/Settings page

View of the controller's start page.

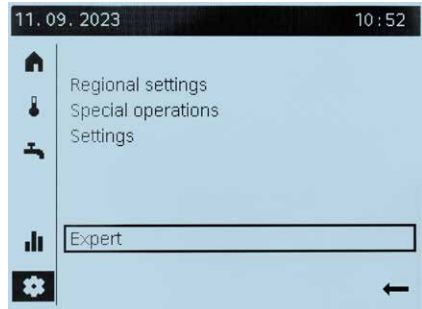

REGIONAL SETTINGS

Regional settings contain basic parameters that can be changed, such as time, date, language.



SPECIAL ACTIONS

They allow such operations as: heat pump reset (in the event of a registered error that prevents the unit from starting up, the unit must be restarted).

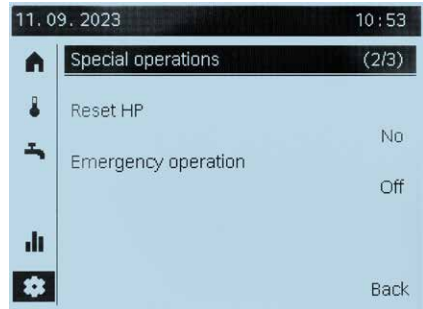

Activating **economy mode** in which the pump only operates in DHW mode and the immersion heaters (if any) are blocked.

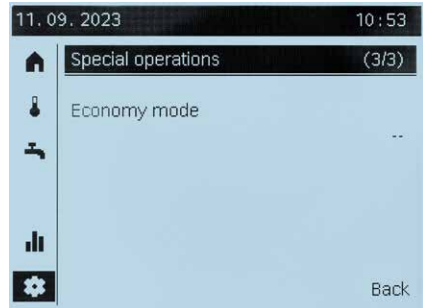

SETTINGS

The settings allow temperatures to be set for each heating/cooling zone:

- comfort
- reduced
- protection

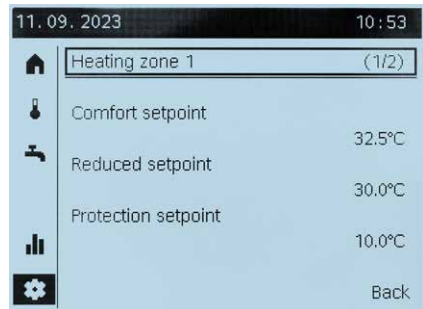

As well as:

- summer/winter temperature limit
- heating curve.

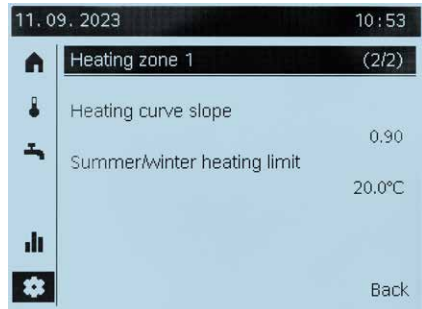

5.12. Login

Access to the individual access levels is password-protected. To log in, go to the Maintenance page, then select the “Expert” line.

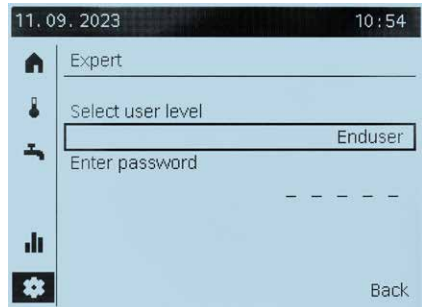

By logging on to the individual access levels, you can change additional parameters, simulate varying operating conditions and more.

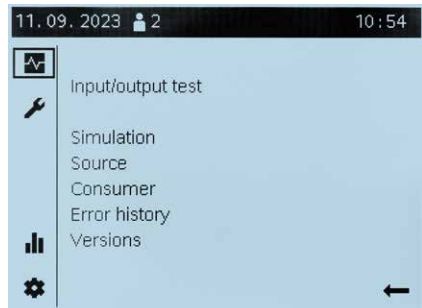

6. ALARMS

If an alarm occurs, it will be displayed in the status bar of the home screen under the bell symbol and the heat pump may stop.

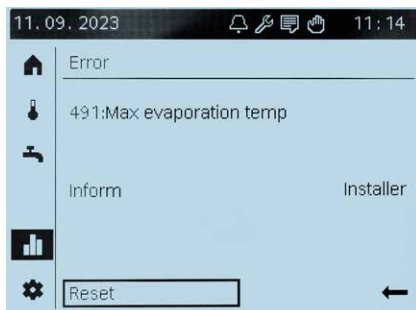

Some alarms do not require manual reset and will be cleared automatically (for example by plugging in a suitable temperature sensor), but some may require manual confirmation – in that case go to the controller's information page and select in the bottom left-hand corner „Reset” and confirm.

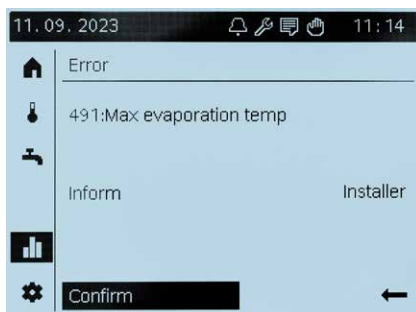

7. MAINTENANCE, INSPECTION AND REPAIR

7.1. Maintenance notes

The heat pump is a highly automated device. Checks on the condition of the unit should be carried out regularly during its operation. If the unit is maintained effectively, its operational reliability and service life will be extended.

- 4) Users should pay attention to the use and maintenance of this device: all safety parameters in the device are set before leaving the factory, do not set them yourself.
- 5) Always check that the power supply and wiring of the device's electrical system is stable, that the electrical components are not malfunctioning, and repair and replace them in a timely manner if necessary.
- 6) Always check the proper filling of the water system, the water tank safety valve, the liquid level regulator and the air discharge device to prevent air from entering the system, thereby reducing water circulation. This may affect the heating performance and reliability of the unit's operation.
- 7) The unit should be kept clean and dry and well ventilated. Clean the air-side heat exchangers of dust and lingering leaves regularly with a vacuum cleaner. This will maintain good heat exchange. It is absolutely forbidden to wash the exchanger with a jet of liquid or pressurized gas.
- 8) Do not accumulate any unnecessary things around the unit to avoid blocking the air inlet and outlet.
- 9) If the device malfunctions and the user is unable to solve the problem, inform the company, reporting the need for service technician assistance.



- 10) Clean the housing only with a damp cloth and a small amount of solvent-free soap. Do not use aerosol agents, surface scratching agents, dishwashing liquids, or cleaning agents containing solvent or chlorine.
- 11) It is recommended to use running water to clean the evaporator of the main unit.

7.2. Safety parameters

- 1) If the pressure in the refrigerant circuit rises above the maximum pressure of about 26.5 bar, the pressure sensor will shut down the heat pump compressor. As soon as the pressure drops to the appropriate value, the compressor will be activated.
- 2) If the heat pump is turned on with the crankcase temperature below 7°C or after 12 hours without power, the compressor crankcase heater will turn on to prevent damage to the compressor during restarting.
- 3) If the temperature measured at the compressor output is higher than the allowed temperature - the compressor will be turned off.
- 4) The amount of water in the heating circuit is monitored by the water flow sensor. If there is a demand for heat with the circulation pump running, the water flow will not be recognized - the compressor will not start.

7.3. Disassembly and disposal

- 1) Be particularly careful when proceeding to disassemble the heat pump or its electrical components and subassemblies.
- 2) Disconnect the heat pump from the power supply before disassembling the unit.
- 3) After disconnecting the power supply, wait 90 seconds before opening the unit. Voltage may remain on the frequency converter during this time.
- 4) After disconnecting the pump from the power supply, the refrigerant should be released from the system in the open air.
- 5) Only persons familiar with the handling of R290 refrigerant may perform the task.
- 6) Use personal protective equipment and carry fire extinguishers.

7.4. Decommissioning the appliance

The decommissioning of electrical and electronic appliances should be conducted in accordance with the current national law in which the appliance was being used.

7.5. Residual risk



- 1) Any cavitation phenomenon that occurs should be removed immediately as it may damage the device.
- 2) Fire outbreak caused by leakage of flammable refrigerant.
- 3) Electric shock due to breakdown or live work.
- 4) Coolant poisoning due to use contrary to the instructions for use.
- 5) Burns caused by low or high temperatures.
- 6) Falling on a slippery surface as a result of using the device contrary to the installer's instructions..

7.6. Error codes

No.: Error text	Place	Error	Acknowledgement	Function „Error repetition”		Heat pump operation	Respon- sibility
		prio	manually	active	1st status message		No.
10: Outside sensor	B9	6	No	No	---	Yes	1 (Installer)
25: Boiler sensor solid fuel	B22	6	No	No	---	Yes	1 (Installer)
26: Common flow sensor	B10	6	No	No	---	Yes	1 (Installer)
27: Common flow sensor 2	B11	6	No	No	---	Yes	1 (Installer)
28: Flue gas temp sensor	B8	6	No	No	---	Yes	1 (Installer)
30: Flow sensor 1	B1	6	No	No	---	Yes	1 (Installer)
31: Flow sensor cooling 1	B16	6	No	No	---	Yes	1 (Installer)
32: Flow sensor 2	B12	6	No	No	---	Yes	1 (Installer)
33: Flow sensor HP	B21	6	No	No	---	Yes	1 (Installer)
35: Source inlet sensor	B91	9	No	No	---	No (param.)	1 (Installer)
36: Hot-gas sensor 1	B81	6	No	No	---	Yes	1 (Installer)
37: Hot-gas sensor 2	B82	6	No	No	---	Yes	1 (Installer)
38: Flow sensor prim contr	B15	6	No	No	---	Yes	1 (Installer)
39: Evaporator sensor	B84	9	No	No	---	No (air-HP)	1 (Installer)
43: Return sensor solid fuel	B72	6	No	No	---	Yes	1 (Installer)
44: Return sensor HP	B71	6	No	No	---	Yes	1 (Installer)
45: Source outlet sensor	B92	9	No	No	---	No (param.)	1 (Installer)
46: Return sensor cascade	B70	6	No	No	---	Yes	1 (Installer)
47: Common return sensor	B73	6	No	No	---	Yes	1 (Installer)
48: Refrigerant sensor liquid	B83	6	No	No	---	Yes	1 (Installer)
50: DHW sensor 1	B3	6	No	No	---	Yes	1 (Installer)
52: DHW sensor 2	B31	6	No	No	---	Yes	1 (Installer)
54: DHW flow sensor	B35	6	No	No	---	Yes	1 (Installer)
57: DHW circulation sensor	B39	6	No	No	---	Yes	1 (Installer)
60: Room sensor 1		6	No	No	---	Yes	1 (Installer)
65: Room sensor 2		6	No	No	---	Yes	1 (Installer)
68: Room sensor 3		6	No	No	---	Yes	1 (Installer)



No.: Error text	Place	Error	Acknowledgement	Function „Error repetition“		Heat pump operation	Responsibility
		prio	manually	active	1st status message		No.
70: Storage tank sensor 1	B4	6	No	No	---	Yes	1 (Installer)
71: Storage tank sensor 2	B41	6	No	No	---	Yes	1 (Installer)
72: Storage tank sensor 3	B42	6	No	No	---	Yes	1 (Installer)
73: Collector sensor 1	B6	6	No	No	---	Yes	1 (Installer)
74: Collector sensor 2	B61	6	No	No	---	Yes	1 (Installer)
76: Special sensor 1	Bx	3	No	No	---	Yes	1 (Installer)
81: LPB short-circuit/comm		6	No	No	---	Yes	5 (none)
82: LPB address collision		3	No	No	---	Yes	5 (none)
83: BSB short-circuit		8	No	No	---	Yes	5 (none)
84: BSB address collision		3	No	No	---	Yes	5 (none)
85: BSB Radio communication		8	No	No	---	Yes	5 (none)
98: Extension module 1		8	No	No	---	Yes	5 (none)
99: Extension module 2		8	No	No	---	Yes	5 (none)
100: 2 clock time masters		3	No	No	---	Yes	5 (none)
102: Clock without backup		3	No	No	---	Yes	5 (none)
105: Maintenance message		5	No	No	---	Yes	1 (Installer)
106: Source temp too low		6	Yes	No	---	No	1 (Installer)
107: Hot-gas compressor 1		9	Yes	Num*	Limit hot-gas compr1	No	2 (Customer service)
117: Water pressure too high	Hx	6	No	No	---	Yes	1 (Installer)
118: Water pressure too low	Hx	6	No	No	---	No	1 (Installer)
121: Flow temp HC1 (zu tief)		3	No	No	---	Yes	1 (Installer)
122: Flow temp HC2 (zu tief)		3	No	No	---	Yes	1 (Installer)
126: DHW charg temp		6	No	No	---	Yes	1 (Installer)
127: Legionella temp		6	No	No	---	Yes	1 (Installer)
134: Common fault HP	E20	9	Yes	Num*	Fault	No	1 (Installer)
138: No control sensor HP		1	No	No	---	No	1 (Installer)
146: Configuration error		3	No	No	---	Yes	5 (none)
171: Alarm contact 1 active	H1/ H31	6	No	No	---	Yes	1 (Installer)
172: Alarm contact 2 active	H2/ H21/ H22/ H32	6	No	No	---	Yes	1 (Installer)
173: Alarm contact 3 active	Ex	6	No	No	---	Yes	1 (Installer)
174: Alarm contact 4 active	H3/ H33	6	No	No	---	Yes	1 (Installer)
176: Water press 2 too high	Hx	6	No	No	---	Yes	1 (Installer)
177: Water press 2 too low	Hx	6	No	No	---	No	1 (Installer)
178: Limit thermostat HC1		3	No	No	---	Yes	1 (Installer)
179: Limit thermostat HC2		3	No	No	---	Yes	1 (Installer)
201: Frost alarm	B21	9	Yes	No	---	No	1 (Installer)
204: Fan overload	E14	9	Yes	Num*	Fan overload	No	1 (Installer)
222: Hi-press on HP op	E10	9	Yes	Num*	High-press HP in operation	No	1 (Installer)
223: Hi-press on start HC	E10	9	Yes	No	---	No	1 (Installer)
224: Hi-press on start DHW	E10	9	Yes	No	---	No	1 (Installer)
225: Low-pressure	E9	9	Yes	Num*	Low-pressure	No	2 (Customer service)

No.: Error text	Place	Error	Acknowledgement	Function „Error repetition”		Heat pump operation	Responsibility
		prio	manually	active	1st status message		No.
226: Compressor 1 overload	E11	9	Yes	Num*	Compressor 1 overload	No	2 (Customer service)w
228: Flow swi heat source	E15	9	Yes	Num*	Flow switch heat source	No	1 (Installer)
229: Press swi heat source	E15	9	Yes	Num*	Press switch heat source	No	1 (Installer)
230: Source pump overload	E14	9	Yes	Num*	Source pump overload	No	1 (Installer)
241: Flow sensor yield	B63	6	No	No	---	Yes	1 (Installer)
242: Return sensor yield	B64	6	No	No	---	Yes	1 (Installer)
243: Swimming pool sensor	B13	6	No	No	---	Yes	1 (Installer)
247: Defrost fault		9	Yes	Num*	Preheating for defrost	No	1 (Installer)
260: Flow sensor 3	B14	6	No	No	---	Yes	---
320: DHW charging sensor	B36	6	No	No	---	Yes	---
321: DHW outlet sensor	B38	6	No	No	---	Yes	---
322: Water press 3 too high	Hx	6	No	No	---	Yes	---
323: Water press 3 too low	Hx	6	No	No	---	No	---
324: BX same sensors		3	No	No	---	Yes	---
325: BX/e/module same sens		3	No	No	---	Yes	---
326: BX/m/grp same sens		3	No	No	---	Yes	---
327: E/module same funct		3	No	No	---	Yes	---
328: Mix group same funct		3	No	No	---	Yes	---
329: E/mod/m/grp same funct		3	No	No	---	Yes	---
330: BX1 no function		3	No	No	---	Yes	---
331: BX2 no function		3	No	No	---	Yes	---
332: BX3 no function		3	No	No	---	Yes	---
333: BX4 no function		3	No	No	---	Yes	---
334: BX5 no function		3	No	No	---	Yes	---
335: BX21 no function		3	No	No	---	Yes	---
336: BX22 no function		3	No	No	---	Yes	---
337: B1 no function		3	No	No	---	Yes	---
338: B12 no function		3	No	No	---	Yes	---
339: Coll pump Q5 missing		3	No	No	---	Yes	---
340: Coll pump Q16 missing		3	No	No	---	Yes	---
341: Coll sensor B6 missing		3	No	No	---	Yes	---
342: Solar DHW B31missing		3	No	No	---	Yes	---
343: Solar integration missing		3	No	No	---	Yes	---
344: Solar buffer K8 missing		3	No	No	---	Yes	---
345: Sol swi pool K18 missing		3	No	No	---	Yes	---
346: Boiler pump Q10 missing		3	No	No	---	Yes	---
347: Solid fuel boil comp sens		3	No	No	---	Yes	---
348: Solid fuel boil addr err		3	No	No	---	Yes	---
349: Buff valve Y15 missing		3	No	No	---	Yes	---
350: Buffer address error		3	No	No	---	Yes	---
351: Prim/sys pump addr err		3	No	No	---	Yes	---
352: Prless header addr err		3	No	No	---	Yes	---
353: Casc sens B10 missing		3	No	No	---	Yes	---



No.: Error text	Place	Error	Acknowledgement	Function „Error repetition”		Heat pump operation	Responsibility
		prio	manually	active	1st status message		No.
354: Special sensor 2	Bx	3	No	No	---	Yes	---
355: 3-ph curr asymmetric	E21/ E22/ E23	9	Yes	Num*	3-ph current asymmetric	No	---
356: Flow switch consumers	E24	9	Yes	Num*	Flow switch consumers	No	---
357: Flow temp cooling 1 (not achieved)		6	No	No	---	Yes	---
358: Soft starter	E25	9	Yes	Num*	---	No	---
359: Div valve cool Y21 miss		3	No	No	---	Yes	---
360: Proc rev va Y22 miss		3	No	No	---	Yes	---
361: Source sens B91 miss		3	No	No	---	Yes	---
362: Source sens B92 miss		3	No	No	---	Yes	---
363: Compr sens B84 miss		3	No	No	---	Yes	---
364: Cool system HP wrong		3	No	No	---	No	---
365: Inst heater Q34 miss		3	No	No	---	Yes	---
366: Room temp sensor Hx		6	No	No	---	Yes	---
367: Room humidity sens Hx		6	No	No	---	Yes	---
368: Flow temp setp readjHx		6	No	No	---	Yes	---
370: Thermodynamic source		9	No	No	---	No	---
369: External		9	No	No	---	No	---
371: Flow temp HC3 (too low)		3	No	No	---	Yes	---
372: Limit thermostat HC3		3	No	No	---	Yes	---
373: Extension module 3		3	No	No	---	Yes	---
385: Mains undervoltage	E21	9	Yes	Num*	Mains undervoltage	Yes	---
388: DHW sensor no function		3	No	No	---	Yes	---
441: BX31 no function		3	No	No	---	Yes	---
442: BX32 no function		3	No	No	---	Yes	---
443: BX33 no function		3	No	No	---	Yes	---
444: BX34 no function		3	No	No	---	Yes	---
445: BX35 no function		3	No	No	---	Yes	---
446: BX36 no function		3	No	No	---	Yes	---
447: BX6 no function		3	No	No	---	Yes	---
452: HX1 no function		3	No	No	---	Yes	---
453: HX3 no function		3	No	No	---	Yes	---
454: HX31 no function		3	No	No	---	Yes	---
455: HX32 no function		3	No	No	---	Yes	---
456: HX33 no function		3	No	No	---	Yes	---
457: BX7 no function		3	No	No	---	Yes	---
462: BX8 no function		3	No	No	---	Yes	---
463: BX9 no function		3	No	No	---	Yes	---
464: BX10 no function		3	No	No	---	Yes	---
465: BX11 no function		3	No	No	---	Yes	---
466: BX12 no function		3	No	No	---	Yes	---
467: BX13 no function		3	No	No	---	Yes	---
468: BX14 no function		3	No	No	---	Yes	---
469: HX21 no function		3	No	No	---	Yes	---

No.: Error text	Place	Error	Acknowledgement	Function „Error repetition“		Heat pump operation	Responsibility
		prio	manually	active	1st status message		No.
470: HX22 no function		3	No	No	---	Yes	---
472: Flow sensor cooling 2	B17	6	No	No	---	Yes	---
473: Flow sensor cooling 3	B18	6	No	No	---	Yes	---
474: Flow temp cooling 2 (nicht erreicht)		6	No	No	---	Yes	---
475: Flow temp cooling 3 (nicht erreicht)		6	No	No	---	Yes	---
476: Suction gas sensor	B85	6	No	No	---	No	---
477: Evapor press sensor	H82	6	No	No	---	No	---
479: No refrigerant selected		3	No	No	---	No	---
480: Suction gas sensor EVI	B86	6	No	No	---	No	---
481: Evap press sensor EVI	H86	6	No	No	---	No	---
482: Evapor temp sensor EVI	B87	6	No	No	---	No	---
484: Div valve cool Y45 miss		3	No	No	---	Yes	---
488: Condens press sensor	H83	8	No	No	---	No	---
489: No cascade master		3	No	No	---	Yes	---
490: Cascade source miss		3	No	No	---	Yes	---
491: Max evaporation temp		9	Yes	Num*	Limitation evap temp max	No	---
492: K2/modulat incompatible		3	No	No	---	No	---
493: Outside air sensor	B19	6	No	No	---	Yes	---
494: Outside air Q17 missing	Q17	3	No	No	---	Yes	---
495: Modbus no comm'cation		6	No	No	---	Yes	---
496: Flow sw source int circ		9	Yes	Num*	Flow switch source int circ	No	---
497: Pres sw sourc int circ		9	Yes	Num*	Press switch source int circ	No	---
498: Air quality sensor Hx	Hx	6	No	No	---	Yes	---
499: External source missing		3	No	No	---	No	---
500: Modbus configuration		3	No	No	---	Yes	---
501: Suction gas sensor 2	B88	6	No	No	---	No	---
502: Sourc int circ flow sens	B93	6	No	No	---	No	---
503: Sourc int circ ret sens	B94	6	No	No	---	No	---
504: Pres diff proc reversal		6	Yes	Yes	Limit pres diff proc revers	No	1 (Installer)
505: Expansion valve evap		6	Yes	No	---	No	---
506: Suppl source missing		6	No	No	---	Yes	---
511: Leg temp circ pipe		6	No	No	---	Yes	---
517: Room humidity sensor 1		6	No	No	---	Yes	---
518: Room humidity sensor 2		6	No	No	---	Yes	---
519: Room humidity sensor 3		6	No	No	---	Yes	---
521: Modbus slave port 1		6	No	No	---	Yes/No**	---
522: Modbus slave port 2		6	No	No	---	Yes/No**	---
523: Modbus slave port 3		6	No	No	---	Yes/No**	---
524: Modbus slave port 4		6	No	No	---	Yes/No**	---
525: Modbus slave port 5		6	No	No	---	Yes/No**	---
526: Modbus slave port 6		6	No	No	---	Yes/No**	---
527: Modbus slave port 7		6	No	No	---	Yes/No**	---



No.: Error text	Place	Error	Acknowledgement	Function „Error repetition”		Heat pump operation	Responsibility
		prio	manually	active	1st status message		No.
528: Modbus slave port 8		6	No	No	---	Yes/No**	---
529: Superheat controller		6	No	No	---	No	---
530: Superheat controller 2		6	No	No	---	No	---
531: Special sensor 3		6	No	No	---	Yes	---
532: Special sensor 4		6	No	No	---	Yes	---
533: Special sensor 5		6	No	No	---	Yes	---
534: Special sensor 6		6	No	No	---	Yes	---
535: Special sensor 7		6	No	No	---	Yes	---
536: Special sensor 8		6	No	No	---	Yes	---

* Num: These plant states do not directly lead to an error message, but first deliver a status message upon initial startup. An error message is delivered only if the error recurs the number of times set for an adjustable period of time.

** Yes/No: As per ACS Parameter „Source fault for Modbus failure” in menu „Setup for Modbus experts” (s.Section 6.23).

Maintenance codes

Maintenance text	Prio	Cause
0: No maintenance message pending	0	
5: Water pressure too low	9	Water pressure 1 in heating circuit is below the set limit
6: Heat pump hours run	6	Hours or operation since maintenance
7: Number heat pump starts exceeded	6	Number of starts since maintenance
8: Too many starts compressor 1	9	Ratio of heat pump starts to runtime is too high
10: Change battery outside sensor	6	Battery is nearly empty
11: DHW storage tank time interval exceeded	6	Time since maintenance
12: DHW charging temp heat pump too low	6	Minimum DHW temperature is not reached with the heat pump
13: Differential condenser max / week exceeded	3	To little flow in heating circuit (e.g. due to a closed thermostatic valve)
14: Differential condenser min / week exceeded	3	Too much flow in the heating circuit or heat pump does not supply sufficient output (e.g. loss of refrigerant)
15: Differential evaporator max / week exceeded	3	Too little flow in source circuit (e.g. dirty heat exchanger)
16: Differential evaporator min / week exceeded	3	"Too much flow in source circuit or heat pump does not supply sufficient output (e.g. loss of refrigerant)"
17: Heat pump time interval exceeded	6	Time since maintenance
18: Water pressure 2 too low	9	Water pressure 2 in heating circuit is under the set limit
21: Flue gas temp too high	6	Maximum flue gas temperature is exceeded
22: Water pressure 3 too low	9	Water pressure 3 in the heating circuit is below the set limit
26: Maintenance interval ventilation 1 expired 26:Ventilation 1	6	The set maintenance interval for ventilation 1 was exceeded
27: Maintenance interval ventilation 2 expired 27:Ventilation 2	6	The set maintenance interval for ventilation 2 was exceeded
28: Maintenance interval ventilation 3 expired 28:Ventilation 3	6	The set maintenance interval for ventilation 3 was exceeded

Tab. 13. Errors and security alerts

Heat pump startup checklist

HEAT PUMP INSTALLATION

Was the device installed according to the instructions YES*

Indoor Unit:

Installation site is dry and protected from frost YES*

Installation spacing is maintained YES*

The unit has been leveled YES*

Outdoor Unit:

Installation spacing is maintained YES*

The unit has been leveled YES*

Ground mounting YES*, height above ground:cm

Type of assembly: stand + rubber feet YES / optional rubber base YES

Acoustic separation (the water system does not transmit vibrations to the building structure) YES*

Outdoor Unit – Protective Area:

Dimension of the protective area in accordance with the requirements of the installation instructions YES*

No openings in the building (windows, vent openings, doors, etc.) YES*

No open lines in the sewer system, or cavities where escaping refrigerant could accumulate YES*

No ignition sources (lamps, electrical sockets, lights, etc.) YES*

Condensate drainage:

No direct connection to the sewer system YES*

Gravel ballast/absorbent substrate YES*

Heating wire inserted into the condensate drain funnel and connected YES*

No siphons in the condensate drainage YES*

Condensate drain protected from frost YES*

Checking the drainage of condensate flow YES*

* - mandatory fields - condition for starting up the device



HEATING SYSTEM

Heating circuit installation:

Installation in accordance with the manufacturer's recommendations YES*

New installation Upgraded installation

Heating type: floor heating / radiators / other

Correctly connected supply and return pipes of central heating circuits YES*

Safety valve has been installed YES*

Outer pipes in UV- and high-temperature-resistant insulation YES*

Thickness of external pipe insulation according to the requirements ($\lambda \leq 0,035$): YES*

- inner diameter of the pipe less than 22 mm - insulation thickness of 20 mm;
- inner diameter of the pipe from 22 to 35 mm - insulation thickness 30 mm;
- inner pipe from 35 to 100 mm - insulation thickness equal to the inner diameter of the pipe;
- inner pipe more than 100 mm - insulation thickness of 100 mm.

Dirt filter installed on the return of the heating system YES*

Installed magneto-demulsifier on the return of the heating system YES*

The minimum water charge necessary for proper operation and defrosting of the outdoor unit is provided YES*

The minimum required water flow through the system has been ensured YES*, it is [l/min]

An expansion vessel was installed, the capacity of the vessel L YES*

Additional vent valves YES units

Shut-off valves on the supply on the return

Drain valves on the supply * on the return *

Number of heating circuits one two

Water in the central heating + DHW system (according to the installer's statement)

Heating water quality in accordance with the requirements of the instructions YES*

Heating system pressure bar

Checked for leaks in the installation YES*

The installation was flushed prior to connecting the equipment YES*

Installation filled and vented YES*

DHW safety group installed YES*

Checking the correct operation of the water pump and the direction of flow YES*

* - mandatory fields - condition for starting up the device

System separation:

Heat exchanger installed YES NO If yes:

Type of antifreeze medium in the heat pump circuit:

Freezing point°C

Heat pump circuit vented YES*

Heat pump circuit pressure bar

Connecting the buffer in parallel / in series

Notes:

ELECTRICAL INSTALLATION

All electrical connections of modules and devices were routed according to the diagram YES*

Electrical wires protected inside the electrical box against pulling out YES*

Access to the electrical system, circuit breakers and protection is provided YES*

Protective and grounding wires connected YES*

Temperature sensors connected according to the instructions YES*

Control wires and sensors routed at a distance of min. 100mm from power wires YES*

Correct 3-phase power cable used min. 5x4mm² */**

The correct overcurrent circuit breakers were used for the units:

- ZHHH-01-10K-R290-R5: 10A B characteristics, 3-phase, 3L+N YES*

- ZHHH-01-15K-R290-R5: 16A B characteristics, 3-phase, 3L+N YES*

In both cases for the controller: overcurrent circuit breaker 6A characteristic B, 1-phase, 1L+N YES*

Differential protection used: YES*** TYPE

In case of option with a heater:

An overcurrent circuit breaker for the heater was used: 16A characteristic B, 3-phase, 3L+N YES*

Notes:

* - mandatory fields - condition for starting up the device

** - the wire should be selected according to the parameters of the fuse used

*** - it is required to use residual current protection in accordance with applicable standards



SETTINGS, COMMISSIONING, HANDOVER TO USER

- Quick guide successfully completed YES*
- Operating mode set CH / CH+DHW / DHW
- Target temperature set CH: heating curve / fixed value°C
- Target temperature set of DHW: fixed value°C
- Additional heat source none dry contact integrated heater
- Bivalent point C.H.°C
- DHW bivalent point°C

Notes:

.....
Installer

.....
Person executing launch

Handover to User

- Heat pump operation instruction YES*
- Safety instructions on R290 refrigerant YES*
- Function and location of safety devices YES*
- Information on regular maintenance and inspections YES*
- Instructions and product documentation have been provided YES*

.....
Customer

* - mandatory fields - condition for starting up the device



PRODUCER OF PROFESSIONAL REFRIGERATION EQUIPMENT

Siedziba główna / Produkcja
Headquarter / Factory

43-254 Warszowice
ul. Gajowa 5
Poland

Produkcja
Factory

43-240 Żory
al. Jana Pawła II 46
Poland

Sekretariat
Secretariat

+48 32 494 00 00
info@jbg2.com



PRZEDSTAWICIEL REGIONALNY
REGIONAL REPRESENTATIVE

jbg2.com